



INSTRUCTIONS FOR:

ARC WELDERS

MODELS Nos: **140XT.V2**
 160XT.V2





INSTRUCTIONS FOR:
ARC WELDER 140AMP, 160AMP WITH ACCESSORY KIT
 MODEL Nos: **140XT.V2, 160XT.V2**

Thank you for purchasing a Sealey product. Manufactured to a high standard, this product will, if used according to these instructions, and properly maintained, give you years of trouble free performance.

IMPORTANT: PLEASE READ THESE INSTRUCTIONS CAREFULLY. NOTE THE SAFE OPERATIONAL REQUIREMENTS, WARNINGS & CAUTIONS. USE THE PRODUCT CORRECTLY AND WITH CARE FOR THE PURPOSE FOR WHICH IT IS INTENDED. FAILURE TO DO SO MAY CAUSE DAMAGE AND/OR PERSONAL INJURY AND WILL INVALIDATE THE WARRANTY. KEEP THESE INSTRUCTIONS SAFE FOR FUTURE USE.



Read Instructions



Wear Eye Protection



Wear A Welders Mask



Wear Protective Gloves



Wear Protective Clothing

1. SAFETY

1.1. ELECTRICAL SAFETY

WARNING! It is the responsibility of the owner and the operator to read, understand and comply with the following: You must check all electrical products, before use, to ensure that they are safe. You must inspect power cables, plugs, sockets and any other connectors for wear or damage. You must ensure that the risk of electric shock is minimised by the installation of appropriate safety devices. A Residual Current Circuit Breaker (RCCB) should be incorporated in the main distribution board. We also recommend that a Residual Current Device (RCD) is used. It is particularly important to use an RCD with portable products that are plugged into a supply which is not protected by an RCCB. If in any doubt consult a qualified electrician. You may obtain a Residual Current Device by contacting your Sealey dealer. You must also read and understand the following instructions concerning electrical safety.

- 1.1.1. The **Electricity at Work Act 1989** requires that all portable electrical appliances, if used on business premises, are tested by a qualified electrician, using a Portable Appliance Tester (PAT), at least once a year.
- 1.1.2. The **Health & Safety at Work Act 1974** makes owners of electrical appliances responsible for the safe condition of those appliances and the safety of the appliance operators. If in any doubt about electrical safety, contact a qualified electrician.
- 1.1.3. Ensure that the insulation on all cables and on the appliance is safe before connecting it to the power supply. See 1.1.1. and 1.1.2. and use a Portable Appliance Tester.
- 1.1.4. Ensure that cables are always protected against short circuit and overload.
- 1.1.5. Regularly inspect power supply cables and plugs for wear or damage and check all connections to ensure that none is loose.
- 1.1.6. **Important:** Ensure that the voltage marked on the appliance matches the power supply to be used and that the plug is fitted with the correct fuse - see fuse rating at right.
- 1.1.7. **DO NOT** carry the appliance by the power cable.
- 1.1.8. **DO NOT** pull the plug from the socket by the cable.
- 1.1.9. **DO NOT** use worn or damaged cables, plugs or connectors. Immediately have any faulty item repaired or replaced by a qualified electrician. When a BS 1363/A UK 3 pin plug is damaged, cut the cable just above the plug and **dispose of the plug safely.** Fit a new plug according to the following instructions (UK only).

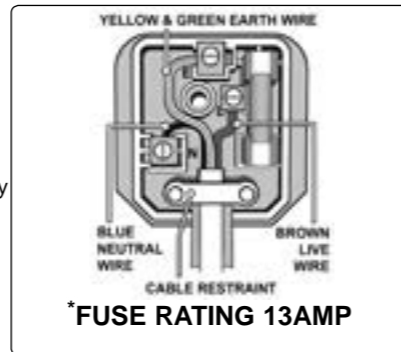

- a) Connect the **GREEN/YELLOW** earth wire to the earth terminal 'E'.
 - b) Connect the **BROWN** live wire to the live terminal 'L'.
 - c) Connect the **BLUE** neutral wire to the neutral terminal 'N'.
 - d) After wiring, check that there are no bare wires, that all wires have been correctly connected, that the cable outer insulation extends beyond the cable restraint and that the restraint is tight.
- Double insulated products, which are always marked with this symbol , are fitted with live (brown) and neutral (blue) wires only. To rewire, connect the wires as indicated above - **DO NOT** connect either wire to the earth terminal.
- 1.1.10. Products which require more than 13 amps are supplied without a plug. In this case you must contact a qualified electrician to ensure that a suitably rated supply is available. We recommend that you discuss the installation of an industrial round pin plug and socket with your electrician.
 - 1.1.11. If an extension reel is used it should be fully unwound before connection. A reel with an RCD fitted is preferred since any appliance plugged into it will be protected. The cable core section is important and should be at least 1.5mm², but to be absolutely sure that the capacity of the reel is suitable for this product and for others which may be used in the other output sockets, we recommend the use of 2.5mm² section cable.
- WARNING!** Be very cautious if using a generator to power the welder. The generator must be self-regulating and stable with regard to voltage, wave form and frequency. The output must be greater than the power consumption of the welder. If any of these requirements is not met the electronics within the welder may be affected.
- NOTE:** The use of an unregulated generator may be dangerous and will invalidate the warranty on the welder.
- WARNING!** The welder may produce voltage surges in the mains supply which can damage other sensitive equipment (e.g. computers). To prevent this happening, it is recommended that the welder is connected to a power supply that does not feed any sensitive equipment.
- 1.1.12. ***IMPORTANT! IF USING WELDER TO FULL CAPACITY, WE RECOMMEND A 16AMP SUPPLY. WE RECOMMEND YOU DISCUSS THE INSTALLATION OF A 16AMP INDUSTRIAL ROUND PIN PLUG AND SOCKET WITH YOUR ELECTRICIAN.**

1.2. GENERAL SAFETY

- WARNING!** Arc welding produces sparks, fused metal projectiles and fumes which can be dangerous.
- WARNING:** Unplug from the mains power supply before performing maintenance or service.
- Keep the welder and cables in good working order and condition. Take immediate action to repair or replace damaged parts. Replace or repair damaged parts. Use genuine parts only, unauthorised parts may be dangerous and will invalidate the warranty.
- Keep the welder clean for best and safest performance.
- Locate welder in a suitable work area. Ensure area has adequate ventilation as welding fumes can be harmful.
- Keep work area tidy and free from unrelated materials. Also ensure work area has adequate lighting and a fire extinguisher is at hand.
- WARNING:** You **MUST** use an appropriate shaded lens welding face mask (contact your Sealey dealer for details). **Permanent eye damage may result if you do not use correct eye protection.** Also wear safety welding gauntlets and dry, oil free safety protective clothing to protect yourself from sparks and hot droplets of fused metal. Cover exposed flesh to avoid potential burns from the ultraviolet rays of the arc. Use non-reflective welding curtains to protect other people in the area.
- Check you have good ventilation and that air can flow freely around the welder.
- DANGER!** Ensure no flammable or combustible materials are near work area. Welding containers or pipes which hold, or have held dangerous gases or substances may explode or burn. Materials cleaned with chlorinated solvents, or varnished surfaces pose danger of toxic fumes.
- Keep unauthorised persons at a safe distance from the work area. Persons within the work area are subject to the same dangers as the person welding and must take the same precautions.
- DO NOT** weld on pressurised containers.
- Remove ties, watches, rings and other jewellery and contain long hair.
- DO NOT** use the welder for any purpose other than that for which it is designed.
- DO NOT** use the welder in damp or wet locations.
- DO NOT** stand welder on a metal workbench, car bodywork or similar object.
- DO NOT** touch any live metal parts or the electrode while the machine is switched on.
- DO NOT** weld without a welding safety head shield, gauntlets and appropriate protective clothing.
- DANGER! DO NOT** weld near inflammable materials - solids, liquids, or gases.
- DO NOT** operate welder while under the influence of drugs, alcohol, other medication, or if you are tired.
- DO NOT** operate the welder if it or the cables are damaged.
- DO NOT** allow untrained persons to operate the welder.
- DO NOT** pull welder by the cable, or electrode holder. **DO NOT** bend or strain cables, protect from sharp or abrasive items. **DO NOT** stand on cables or leads. Protect from heat. Long lengths of slack must be gathered and neatly coiled. **DO NOT** place cables where they endanger others.
- DO NOT** touch the electrode holder or workpiece immediately after welding as they will be very hot. Allow to cool.
- DO NOT** open the cover of the machine. Switch off machine and remove the plug from the power supply after use.
- The electromagnetic fields generated by the welding process may interfere with the operation of electrical and electronic equipment.
- Users of vital electrical or electronic devices (e.g. pace-makers, respirators etc.) should consult a doctor before entering areas where welding machines are in use. (see Section 8).
- Users of vital electrical or electronic devices should not use any welding machine.

2. INTRODUCTION

Manufactured to exacting standards these models meet all relevant CE requirements. Fitted with forced air cooling system, these welders have increased duty cycle and performance. All models feature a double vented, wraparound shell fitted to a heavy-duty chassis. Screw type, stepless welding control allows fine adjustment of current. Each welder is fitted with carry handle. Models supplied with accessory kit including electrode holder, earth clamp and chipping hammer/wire brush.

This instruction manual contains the information required to prepare your arc welding set for welding. The instructions are not intended to show you how to become a welder. If you have no experience, we recommend that you seek training from an expert source. Arc welding is relatively easy to perform, but does require a steady hand and time practising with scrap metal, as it is only with continued practice that you will achieve the desired results.

3. SPECIFICATION

Model No:140XT.V2
 Welding Current:.....45-140A
 Electrode Capacity: Ø1.6-3.2mm
 Cooling:Forced Air
 Output Cable: 10mm²
 No Load Voltage:.....48V
 Absorbed Power:.....3kW
 Power Input: 230V - 1ph
 Weight: 17kg
 Max. Permissible System Impedance:..... Zmax(0.22Ω)

Model No:160XT.V2
 Welding Current:.....55-160A
 Electrode Capacity: Ø2.0-4.0mm
 Cooling:Forced Air
 Output Cable: 16mm²
 No Load Voltage:.....50V
 Absorbed Power:.....3kW
 Power Input: 230V - 1ph
 Weight: 18kg
 Max. Permissible System Impedance:..... Zmax(0.18Ω)

4. CONTENTS

- 4.1. See Fig.1.

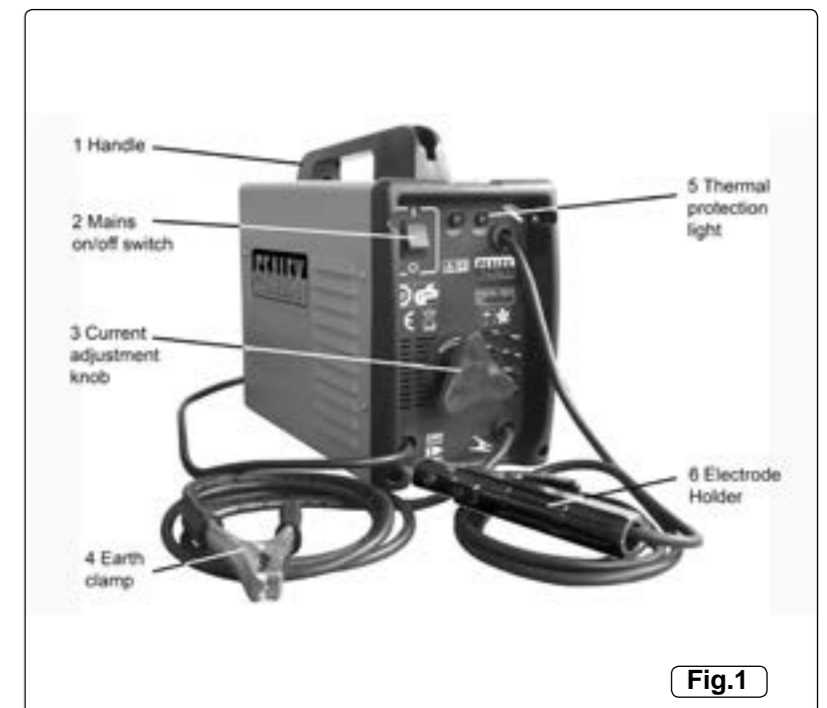
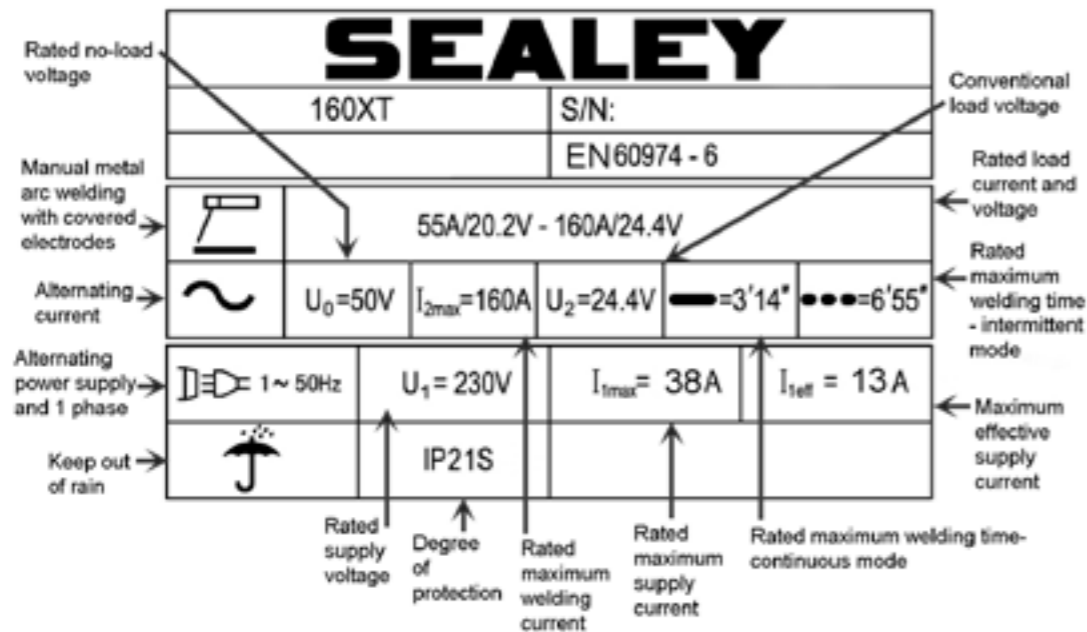

Fig.1

5. RATINGS PLATE GUIDE

FOR FURTHER CLARIFICATION OF SYMBOLS REFER TO BRITISH STANDARD EN 60974-6
(For actual ratings of your model refer to the top cover)

Fig.2



6. OPERATION

WARNING! If you have no welding experience, we recommend you seek supervised training from an expert source.

- 6.1. Introduction.** Your welder features a single phase transformer with a drooping characteristic suitable for welding with an alternating current using stick electrodes with diameters from 1.5mm to the highest electrode diameter as shown on the chart in Fig.6.
- 6.2. Current regulation.** The intensity of the welding current can be adjusted by means of a manually operated magnetic shunt. See Fig.1-3. To increase the current turn the knob clockwise whilst making reference to the graduated scale on the top of the machine (See Fig.3). To decrease the current turn the knob anti clockwise. Note: Set the current to the desired level before commencing welding. **DO NOT** operate the current regulation mechanism whilst welding is in progress.
- 6.3. Thermostatic Protection.**
- 6.3.1. Temperature Control Indicator Light.**
When the machine is overheating, it cuts off the power and the indicator light comes on. When the temperature has dropped to the recovery temperature, the machine can automatically restart and the indicator light will go off. See Fig.1-5.
- 6.3.2. Temperature Protection Indicator Light.**
If the Temperature Controller fails, the protector will cut off the power and the indicator light comes on. Temperature protection can not resume automatically. If needed, please follow the methods below for recovery operations:
1. Turn off the machine's power.
2. Open the cover of the machine.
3. When the temperature protector pops up on the red contacts, such as in the picture right, it means the machine has cut off.
4. Press the red contacts on the thermal protection this means the machine is now in a normal state. As you use larger welding rods you may experience a temporary current shut off. The larger the welding rod, the greater the current required, consequently, the hotter the machine will become and the quicker it will cut out.
- 6.4. Setting up the welder.**
- 6.4.1.** Ensure the machine is turned off from the mains power supply. (See fig.1-2).
- 6.4.2.** Attach the earth clamp to a point on the workpiece that has been cleanly ground to provide good contact. Attach it as close as possible to the area you will be welding.
- 6.4.3.** Select the diameter of electrode to be used in relation to the type of weld to be made. Consideration should be given to the fact that higher current values should be used for flat welding, whereas for vertical or over head welding lower current values are required. Insert the electrode into the electrode holder. Ensure there is a good connection. Ensure welding surfaces are kept clean and free from grease, or oil.
- 6.4.4.** Establish the welding current required in relation to the diameter of electrode you are using by making reference to the table in Fig.6.
- 6.4.5.** Set the current required in amps using the control knob on the front panel. See Fig.1-3. The current set can be read from the graduated scale on the top of the machine. See Fig.3.
- 6.5. Commencing Welding** It is advisable to practice on scrap metal first, especially where potentially difficult welds are to be undertaken.
- WARNING!** Remember to wear a full face welding mask, gauntlets and protective clothing and ensure you have read, understood and apply safety instructions. Wear goggles whilst chipping slag.
- 6.5.1. DO NOT** switch on the power supply until you are fully ready to start welding.
- 6.5.2.** Place the face mask in front of your face.
- 6.5.3.** To strike the arc tap the electrode lightly on the workpiece as if striking a match. **DO NOT** hit the electrode on workpiece as this may damage the stick.

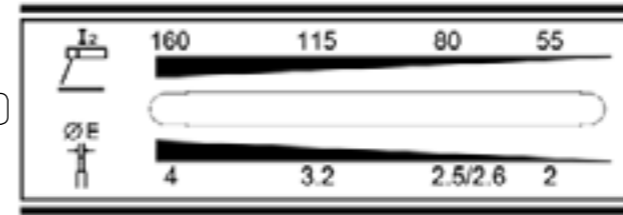
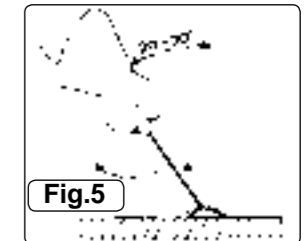
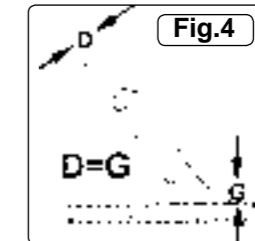

Fig.3



- 6.5.4.** As soon as the arc is struck maintain a steady gap between the end of the electrode and the workpiece equal to the diameter of the electrode in use (See Fig.4). Try to maintain this gap continuously through out the duration of the weld. The electrode should also be held at an angle of 20° to 30° from the vertical. (See Fig.5).
- 6.5.5.** At the end of the weld bead, move the tip of the electrode backwards in order to fill the weld crater. Quickly lift the electrode from the weld pool to extinguish the arc. Refer to Fig.7 for a welding fault analysis.
- 6.5.6.** If the electrode sticks, you may be holding it too close to the workpiece. Pull sharply to the left, and then to the right to free the electrode.
- 6.5.7.** After welding, chip off the slag with a chipping hammer. Wear goggles.
- 6.5.8.** Switch off the welder and disconnect it from the mains power supply. Remember that the workpiece and the electrode will still be very hot.
- WARNING!** Use pliers to remove the hot consumed electrodes or to move the hot welded pieces.
- 6.5.9.** When welding has finished remove the electrode from the electrode holder as a safety precaution.

Electrode Diameter (mm)	Welding Current (Amp)	
	Min	Max
1.6	25	50
2.0	45	60
2.5	55	100
3.2	80	140
4.0	85	160

Fig.6

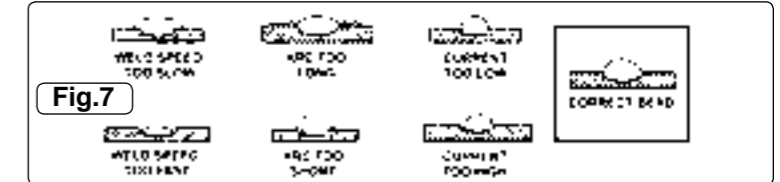

7. MAINTENANCE

WARNING! Ensure the welder is disconnected from the electrical mains power supply before attempting any service or maintenance tasks outlined below.

- 7.1.** Keep the welder clean and dry at all times. Use a dry cloth to clean the unit.
- 7.2.** Keep all electrodes clean and dry and ensure all cables are in good condition.
- 7.3.** Inspect the welder regularly, with a frequency depending on use and the dustiness of the environment. Remove dust deposits from the transformer using a jet of dry compressed air, (Max 10bar).
- 7.4.** At the same time make sure that the electrical connections are tight and check the wiring for damage to the insulation.
- 7.5.** If necessary use a very thin layer of high temperature grease, to lubricate the moving parts of the regulators (threaded shaft, sliding surfaces, shunts etc).
- 7.6.** After these light maintenance operations ensure that the welder covers are replaced and that all fastening screws are fully tightened.
- 7.7.** Use an authorised service agent for any other maintenance or service requirements.
- WARNING!** Never perform welding operations with the covers removed.

8. COMPATIBILITY

- 8.1.** THIS EQUIPMENT IS IN CONFORMITY WITH THE EUROPEAN STANDARD ON THE ELECTROMAGNETIC COMPATIBILITY OF ARC WELDING EQUIPMENT AND SIMILAR PROCESSES (E.G. ARC AND PLASMA CUTTING)
- 8.2. Protection against interference (EMC).** The emission limits in this standard may not, however, provide full protection against interference to radio and television reception when the equipment is used closer than 30m to the receiving antenna. In special cases, when highly susceptible apparatus is being used in close proximity, additional mitigation measures may have to be employed in order to reduce the electromagnetic emissions. At the same time there could occur some potential difficulties in having electromagnetic compatibility in a non-industrial environment (e.g. in residential areas). Therefore it is most important that the equipment is used and installed according to the following instructions.
- 8.3. Installation and use.** The user is responsible for installing and using the equipment according to these instructions. If electromagnetic disturbances are detected, then it shall be the responsibility of the user of the equipment to resolve the situation with the technical assistance of the supplier. In some cases this remedial action may be as simple as earthing the circuit (see Note). In other cases it could involve constructing an electromagnetic screen, enclosing the welding power source and the work, complete with associated input filters. In all cases the electromagnetic disturbances shall be reduced to the point where they are no longer troublesome.
- Note:** The welding/cutting circuit may or may not be earthed for safety reasons. Changing the earthing arrangements should only be authorised by a person who is competent to assess whether the changes will increase the risk of injury, e.g. by allowing parallel welding/cutting circuit return paths which may damage the earth circuits of other equipment. Further guidance is given in IEC 974-13 'Arc Welding Equipment - Installation and Use.'
- 8.4. Assessment of area.** Before installing the equipment the user shall make an assessment of potential electromechanical problems in the surrounding area. The size of the surrounding area to be considered will depend on the structure of the building and other activities that are taking place. The surrounding area may extend beyond the boundaries of the premises.
- The following shall be taken into account :
- Other supply cables, control cables, signalling and telephone cables, above, below and adjacent to the welding equipment.
 - Radio and television transmitters and receivers.
 - Computer and other control equipment.
 - Safety critical equipment, e.g. security monitoring of industrial equipment.
 - The health of people in the vicinity, e.g. persons fitted with a pacemaker or hearing aid.
 - Equipment used for calibration or measurement.
 - The immunity of other equipment in the environment. The user shall ensure that other equipment being used in the environment is compatible. This may require additional protective measures.
 - The time of day that welding and other activities are to be carried out.
- 8.5. Mains supply.** The equipment should be connected to the mains supply according to these instructions. If interference occurs, it may be necessary to take additional precautions such as filtering of the mains supply. Consideration should also be given to shielding the supply cable of permanently installed equipment in metallic conduit or equivalent. This shielding should be connected to the power source so that good electrical contact is maintained between the conduit and the welding power source enclosure.

- 8.6. **Maintenance of the equipment.** The equipment should be routinely maintained according to these instructions. All access and service covers should be closed and properly fastened when the welding equipment is in operation. The welding equipment should not be modified in any way except for those changes and adjustments covered in these instructions. In particular, the spark gaps of any arc striking and stabilising devices should be adjusted and maintained according to the instructions.
- 8.7. **Cables.** The welding/cutting cables should be kept as short as possible and should be positioned close together, running at or close to the floor level.
- 8.8. **Equipotential bonding.** Bonding of all metallic components in the welding/cutting installation and adjacent to it should be considered. However, metallic components bonded to the workpiece will increase the risk that the operator could receive a shock by touching these metallic components and the electrode at the same time. The operator should be insulated from all such bonded metallic components.
- 8.9. **Earthing of the workpiece.** It is important that the workpiece is separately bonded to earth in addition to the welder/cutter return cable. Where the workpiece is not bonded to earth for electrical safety reasons or because of its size and position, e.g. ship's hull or building steelwork, a connection bonding the workpiece to earth may reduce emissions in some, but not all instances. Care should be taken to prevent the earthing of the workpiece increasing the risk of injury to others or damage to other electrical equipment. Where necessary, the connection of the workpiece to earth should be made by a direct connection to the workpiece, but in some countries where direct connection is not permitted, the bonding should be achieved by a suitable capacitance, selected according to national regulations.
- 8.10. **Screening and shielding.** Selective screening and shielding of other cables and equipment in the surrounding area may alleviate problems of interference. Screening of the entire welding/cutting installation may be considered for special applications.

9. TROUBLESHOOTING

PROBLEM	CAUSE	SOLUTION
Power source fuse blown	Short circuit in either primary or secondary transformer windings	Return to Sealey dealer for assessment/repair
	Electrode has touched earth clamp	Be vigilant to prevent this happening
	Wrongly rated fuse	Install correct fuse
Welder frequently cuts out	The welder is being overworked causing the thermostatic control to activate	Cut out will automatically reset when welder has cooled
	May also be due to a sticking electrode	Cut out will automatically reset when welder has cooled
	Broken fan causing overheating	Repair or replace cooling fan
Cooling fan not working properly	Starting capacitance disabled	Replace capacitor
Difficulty in striking or maintainig an arc	The electrode is damp	Heat it up to 60° - 70° before using
	Wrong type of electrode	Use correct electrode
	Bad connection between earth clamp and workpiece	Grind connection area and reattach clamp
	Regulation screw and nut worn out	Replace worn out parts
	Partial short circuit in transformer windings	Return to Sealey dealer for assessment/repair
Noise from within case when welding	Uneven gap between the moving iron core and static iron core	Return to Sealey Dealer to have cores adjusted



Environmental Protection

Recycle unwanted materials instead of disposing of them as waste. All tools, accessories and packaging should be sorted, taken to a recycling centre and disposed of in a manner which is compatible with the environment. When the product becomes completely unserviceable and requires disposal, drain off any fluids (if applicable) into approved containers and dispose of the product and the fluids according to local regulations.



WEEE Regulations

Dispose of this product at the end of its working life in compliance with the EU Directive on Waste Electrical and Electronic Equipment (WEEE). When the product is no longer required, it must be disposed of in an environmentally protective way. Contact your local solid waste authority for recycling information.

Parts support is available for this product. To obtain a parts listing and/or diagram, please log on to www.sealey.co.uk, email sales@sealey.co.uk or telephone 01284 757500.

NOTE: It is our policy to continually improve products and as such we reserve the right to alter data, specifications and component parts without prior notice.
IMPORTANT: No liability is accepted for incorrect use of this product.
WARRANTY: Guarantee is 12 months from purchase date, proof of which will be required for any claim.





Sole UK Distributor, Sealey Group,
 Kempson Way, Suffolk Business Park,
 Bury St. Edmunds, Suffolk,
 IP32 7AR



01284 757500



01284 703534

www.sealey.co.uk
sales@sealey.co.uk