



BRITTOOL

Quality Since 1908



Product Catalogue 2009



www.britool.com



BRITTOOL

Quality Since 1908



Product Catalogue 2009



BRITTOOL

Quality Since 1908

BRITTOOL: A HISTORY OF EXCELLENCE

The British Tool and Engineering Company – the company which founded the Britool brand – first started production in 1908 and Britool has been the number one choice for professional engineers ever since. Demand for the company's products grew strongly between the wars and during the Second World War, Britool was the principal supplier of tools to the British armed forces, supplying over 200 million wrenches, sockets and accessories. The widespread use of Britool products during the war brought the high quality of the brand's products to the attention of a wider audience, significantly increasing market knowledge and made Britool the number one tightening tool brand in the UK.

A FUTURE OF INNOVATION

In 1991, in order to consolidate its position as a premier brand in one of the worlds most competitive markets, Britool joined forces with Facom, Europe's largest hand tool manufacturer. The backing of such strong development facilities and vast technical expertise enabled Britool to maintain its position as the brand of choice for all areas of engineering – from aerospace to industry.

In 2006 Britool and the Facom Group merged with Stanley – the World's largest supplier of tools. Today, backed by the industrial might and expertise of Stanley, Britool maintains its own unique identity and presents a world class product offering. Britool remains one of the worlds most widely respected hand tool brands and remains the engineers' number one choice where quality and performance are essential.



2009

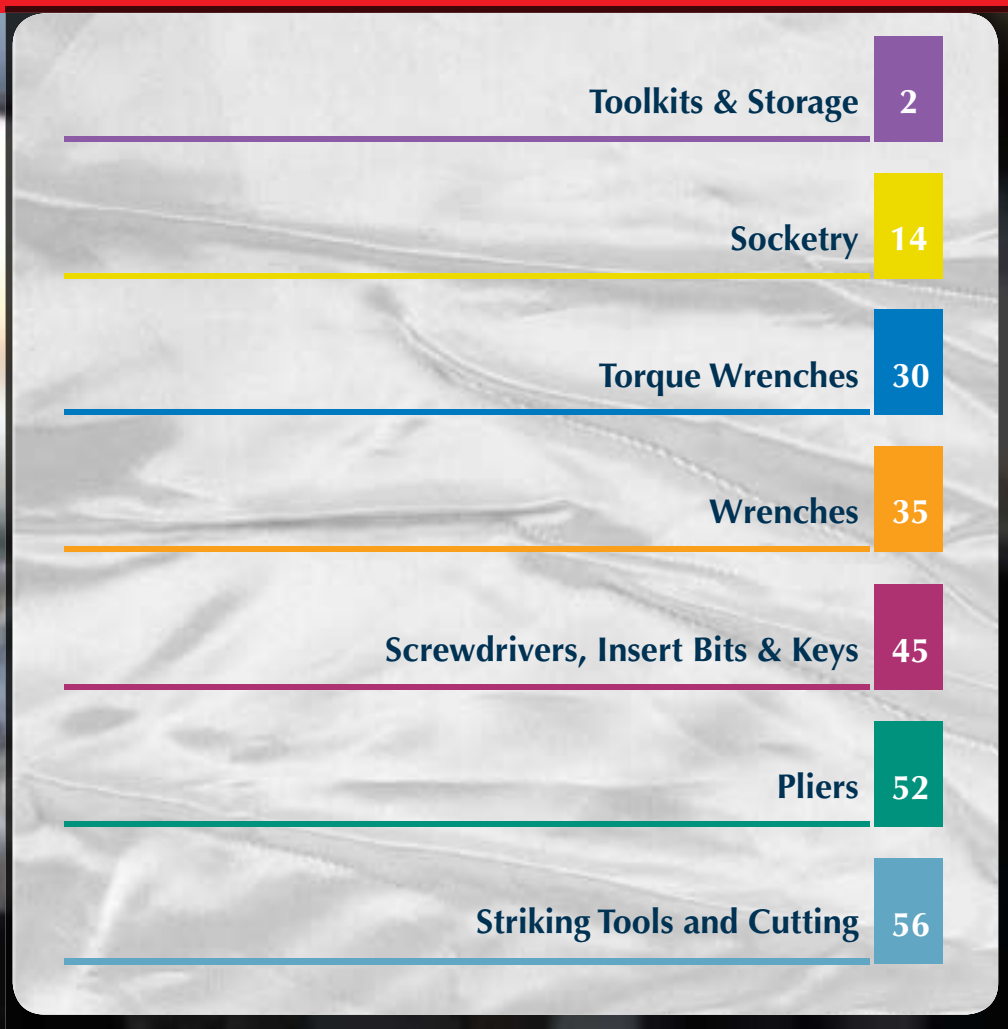

THE BRITool GUARANTEE

All Britool products are manufactured to the highest standards and are guaranteed against defective materials and workmanship when used for the purpose for which they are designed. In the unlikely event that a product fails in normal use, it will be replaced or repaired (for a full listing of the Britool guarantee, please see the listing on page 68).

Toolkits & Storage

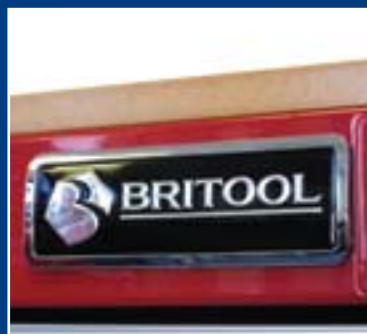
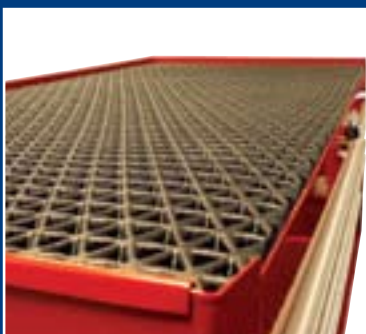

The Britool storage range includes boxes for all applications. All are manufactured under the strictest quality control environment to offer the highest standards of performance. We are confident that whatever model you select, it will provide a high quality storage solution. All Britool toolboxes featured in this section offer a number of common features:

Drawer Slides

All drawers feature high specification ball bearing drawer slides – a sure sign of quality. These allow loads of up to 30kg per drawer, and give a smooth drawer action even when fully loaded.



Rear Locking Bars

The locking mechanism activates securing bars at the rear of the drawer – making it almost impossible to force drawers open by prying.



Fully lockable

All Britool toolboxes feature high quality locks, enabling all drawers to be secured.



Full drawer extension

100% opening gives easy access – even to products stored at the very back of a drawer.



Drawer liners

All Britool toolboxes featured include high density, pre-cut drawer liners.



Manoeuvrability

All roller cabinets have heavy duty 5x2" castors. This cushions the motion of the cabinet when moved over a non smooth surface. This makes movement easier and reduces stress on the cabinet.



Side handles

All tool chests feature cushion grip side handles. Heavy duty models feature twin handles at each end.



Hinged Lids

All tool chest lids have a full width piano hinge – giving a smooth action with increased security.



Twin lid stays

For safety and durability all tool chests are fitted with two lid stays. This removes unnecessary stress from both lid and hinge whilst the lid is open – significantly increasing the life of the tool chest. Heavy duty models feature twin gas struts.

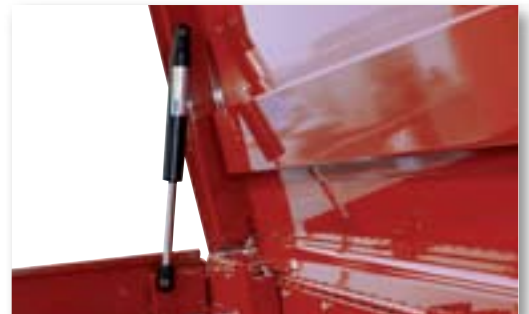

All fixings

Wheels & handles are attached using reinforced holes containing high strength precision cut threaded inserts. This simplifies the attaching or removing of components and also makes a significant contribution to units overall structural strength

All Britool toolboxes are constructed from heavy gauge steel – giving unrivaled durability



- Heavy duty construction designed for heavy use
- Heavy duty ball bearing drawer slides
- Powder coat finish – for improved corrosion resistance
- Heavy duty castors
- Double wall construction – for increased strength and reliability
- Drawer liners included
- Storage compartment

3 Drawer Roller Cabinet

| Ref. | Description | Width mm | Depth mm | Height mm | List £ |
|-------|--------------------|----------|----------|-----------|---------|
| BRCR3 | Overall Dimensions | 676 | 460 | 676 | £378.44 |
| | 3 Drawers | 569 | 412 | 75 | |



- Heavy duty construction designed for heavy use
- Heavy duty ball bearing drawer slides
- Powder coat finish – for improved corrosion resistance
- Heavy duty castors
- Double wall construction – for increased strength and reliability
- Drawer liners included

5 Drawer Roller Cabinet

| Ref. | Description | Width mm | Depth mm | Height mm | List £ |
|-------|--------------------|----------|----------|-----------|---------|
| BRCR5 | Overall Dimensions | 676 | 460 | 860 | £420.49 |
| | 3 Drawers | 569 | 412 | 75 | |
| | 2 Drawers | 569 | 412 | 155 | |



- Heavy duty construction designed for heavy use
- Heavy duty ball bearing drawer slides
- Powder coat finish – for improved corrosion resistance
- Heavy duty castors
- Double wall construction – for increased strength and reliability
- Drawer liners included

5 Drawer Roller Cabinet with Storage Compartment

| Ref. | Description | Width mm | Depth mm | Height mm | List £ |
|-------|---------------------|----------|----------|-----------|---------|
| BRCR6 | Overall Dimensions | 676 | 460 | 995 | £510.59 |
| | 4 Drawers | 569 | 412 | 75 | |
| | 1 Drawer | 569 | 412 | 154 | |
| | Storage Compartment | 569 | 412 | 358 | |



- Heavy duty construction designed for heavy use
- Heavy duty ball bearing drawer slides
- Powder coat finish – for improved corrosion resistance
- Heavy duty castors
- Double wall construction – for increased strength and reliability
- Drawer liners included

5 Drawer Roller Cabinet with Storage Compartment

| Ref. | Description | Width mm | Depth mm | Height mm | List £ |
|---------|---------------------|----------|----------|-----------|---------|
| BRCR6BL | Overall Dimensions | 676 | 460 | 995 | £510.59 |
| | 4 Drawers | 569 | 412 | 75 | |
| | 1 Drawer | 569 | 412 | 154 | |
| | Storage Compartment | 569 | 412 | 358 | |



- Heavy duty construction designed for heavy use
- Heavy duty ball bearing drawer slides
- Powder coat finish – for improved corrosion resistance
- Heavy duty castors
- Double wall construction – for increased strength and reliability
- Drawer liners included



- Heavy duty construction designed for heavy use
- Heavy duty ball bearing drawer slides
- Powder coat finish – for improved corrosion resistance
- Heavy duty castors
- Double wall construction – for increased strength and reliability
- Drawer liners included

11 Drawer Roller Cabinet

| Ref. | Description | Width mm | Depth mm | Height mm | List £ |
|--------|--------------------|----------|----------|-----------|---------|
| BRCR11 | Overall Dimensions | 676 | 460 | 1105 | £594.69 |
| | 4 Drawers | 268 | 412 | 50 | |
| | 5 Drawers | 569 | 412 | 75 | |
| | 2 Drawers | 569 | 412 | 155 | |

11 Drawer Roller Cabinet

| Ref. | Description | Width mm | Depth mm | Height mm | List £ |
|----------|--------------------|----------|----------|-----------|---------|
| BRCR11BL | Overall Dimensions | 676 | 460 | 1105 | £594.69 |
| | 4 Drawers | 268 | 412 | 50 | |
| | 5 Drawers | 569 | 412 | 75 | |
| | 2 Drawers | 569 | 412 | 155 | |



- Heavy duty construction designed for heavy use
- Heavy duty ball bearing drawer slides
- Powder coat finish – for improved corrosion resistance
- Heavy duty castors
- Double wall construction – for increased strength and reliability
- Drawer liners included

7 Drawer Roller Cabinet

| Ref. | Description | Width mm | Depth mm | Height mm | List £ |
|-------|--------------------|----------|----------|-----------|---------|
| BRCR7 | Overall Dimensions | 676 | 460 | 1105 | £548.21 |
| | 5 Drawers | 569 | 412 | 75 | |
| | 2 Drawers | 569 | 412 | 155 | |



- Heavy duty construction designed for heavy use
- Heavy duty ball bearing drawer slides
- Powder coat finish – for improved corrosion resistance
- Heavy duty castors
- Double wall construction – for increased strength and reliability
- Drawer liners included

16 Drawer 41" Tool Cart

| Ref. | Description | Width mm | Depth mm | Height mm | List £ |
|--------|--------------------|----------|----------|-----------|----------|
| BTCR16 | Overall Dimensions | 1067 | 480 | 1010 | £1051.22 |
| | 7 Drawers | 569 | 412 | 75 | |
| | 7 Drawers | 308 | 412 | 75 | |
| | 1 Drawer | 569 | 412 | 155 | |
| | 1 Drawer | 308 | 412 | 155 | |



- Heavy duty construction designed for heavy use
- Gas lid struts- for ease of opening
- Heavy duty ball bearing drawer slides
- Powder coat finish – for improved corrosion resistance
- Double wall construction – for increased strength and reliability
- Drawer liners included

8 Drawer 41" Tool Chest

| Ref. | Description | Width mm | Depth mm | Height mm | List £ |
|--------|--------------------|----------|----------|-----------|---------|
| BTBR8W | Overall Dimensions | 1052 | 470 | 492 | £714.83 |
| | 4 Drawers | 569 | 412 | 75 | |
| | 4 Drawers | 308 | 412 | 75 | |



- Heavy duty construction designed for heavy use
- Tote tray included
- Heavy duty ball bearing drawer slides
- Powder coat finish – for improved corrosion resistance
- Double wall construction – for increased strength and reliability
- Drawer liners included

10 Drawer Tool Chest

| Ref. | Description | Width mm | Depth mm | Height mm | List £ |
|--------|--------------------|----------|----------|-----------|---------|
| BTBR10 | Overall Dimensions | 660 | 410 | 490 | £420.49 |
| | 6 Drawers | 169 | 368 | 50 | |
| | 1 Drawer | 169 | 368 | 154 | |
| | 3 Drawers | 569 | 272 | 75 | |



- Heavy duty construction designed for heavy use
- Tote tray included
- Heavy duty ball bearing drawer slides
- Powder coat finish – for improved corrosion resistance
- Double wall construction – for increased strength and reliability
- Drawer liners included

10 Drawer Tool Chest

| Ref. | Description | Width mm | Depth mm | Height mm | List £ |
|----------|--------------------|----------|----------|-----------|---------|
| BTBR10BL | Overall Dimensions | 660 | 410 | 490 | £420.49 |
| | 6 Drawers | 169 | 368 | 50 | |
| | 1 Drawers | 169 | 368 | 154 | |
| | 3 Drawers | 569 | 272 | 75 | |



- Heavy duty construction designed for heavy use
- Drop down front for complete security
- Tote tray included
- Heavy duty ball bearing drawer slides
- Powder coat finish – for improved corrosion resistance
- Double wall construction – for increased strength and reliability
- Drawer liners included

6 Drawer Tool Chest With Drop Down Front

| Ref. | Description | Width mm | Depth mm | Height mm | List £ |
|--------|--------------------|----------|----------|-----------|---------|
| BTBRD6 | Overall Dimensions | 660 | 307 | 386 | £246.29 |
| | 3 Drawers | 169 | 272 | 50 | |
| | 2 Drawers | 569 | 272 | 50 | |
| | 1 Drawer | 569 | 272 | 75 | |



- Heavy duty construction designed for heavy use
- Drop down front for complete security
- Tote tray included
- Heavy duty ball bearing drawer slides
- Powder coat finish – for improved corrosion resistance
- Double wall construction – for increased strength and reliability
- Drawer liners included

6 Drawer Tool Chest With Drop Down Front

| Ref. | Description | Width mm | Depth mm | Height mm | List £ |
|----------|--------------------|----------|----------|-----------|---------|
| BTBRD6BL | Overall Dimensions | 660 | 307 | 386 | £246.29 |
| | 3 Drawers | 169 | 272 | 50 | |
| | 2 Drawers | 569 | 272 | 50 | |
| | 1 Drawer | 569 | 272 | 75 | |



- Heavy duty construction designed for heavy use
- Tote tray included
- Heavy duty ball bearing drawer slides
- Powder coat finish – for improved corrosion resistance
- Double wall construction – for increased strength and reliability
- Drawer liners included

8 Drawer Tool Chest

| Ref. | Description | Width mm | Depth mm | Height mm | List £ |
|-------|--------------------|----------|----------|-----------|---------|
| BTBR8 | Overall Dimensions | 660 | 307 | 386 | £276.32 |
| | 6 Drawers | 169 | 272 | 50 | |
| | 2 Drawers | 569 | 272 | 75 | |



- Heavy duty construction designed for heavy use
- Heavy duty ball bearing drawer slides
- Powder coat finish – for improved corrosion resistance
- Double wall construction – for increased strength and reliability
- Drawer liners included

8 Drawer Side Cabinet

| Ref. | Description | Width mm | Depth mm | Height mm | List £ |
|-------|--------------------|----------|----------|-----------|---------|
| BSCR8 | Overall Dimensions | 377 | 470 | 860 | £378.44 |
| | 7 Drawers | 308 | 412 | 75 | |
| | 1 Drawers | 308 | 412 | 155 | |



- Heavy duty construction designed for heavy use
- Heavy duty ball bearing drawer slides
- Powder coat finish – for improved corrosion resistance
- Double wall construction – for increased strength and reliability
- Drawer liners included

8 Drawer Side Cabinet

| Ref. | Description | Width mm | Depth mm | Height mm | List £ |
|---------|--------------------|----------|----------|-----------|---------|
| BSCR8BL | Overall Dimensions | 377 | 470 | 860 | £378.44 |
| | 7 Drawers | 308 | 412 | 75 | |
| | 1 Drawers | 308 | 412 | 155 | |



- Powder coat finish – for improved corrosion resistance
- With internal shelf
- Easily attached to roller cabinet (min depth 458mm, min height 875mm)

Side Cabinet

| Ref. | Description | Width mm | Depth mm | Height mm | List £ |
|-------|--------------------|----------|----------|-----------|---------|
| BSCR1 | Overall Dimensions | 375 | 458 | 860 | £162.19 |



- Powder coat finish – for improved corrosion resistance
- With internal shelf
- Easily attached to roller cabinet (min depth 458mm, min height 875mm)

Side Cabinet

| Ref. | Description | Width mm | Depth mm | Height mm | List £ |
|---------|--------------------|----------|----------|-----------|---------|
| BSCR1BL | Overall Dimensions | 375 | 458 | 860 | £162.19 |



- Heavy duty construction designed for heavy use
- Heavy duty ball bearing drawer slides
- Powder coat finish – for improved corrosion resistance
- Double wall construction – for increased strength and reliability
- Drawer liners included

3 Drawer Mid Section

| Ref. | Description | Width mm | Depth mm | Height mm | List £ |
|-------|--------------------|----------|----------|-----------|---------|
| BMSR6 | Overall Dimensions | 660 | 315 | 270 | £150.17 |
| | 2 Drawers | 573 | 262 | 50 | |
| | 1 Drawer | 573 | 262 | 75 | |



- Heavy duty construction designed for heavy use
- Heavy duty ball bearing drawer slides
- Powder coat finish – for improved corrosion resistance
- Double wall construction – for increased strength and reliability
- Drawer liners included

3 Drawer Mid Section

| Ref. | Description | Width mm | Depth mm | Height mm | List £ |
|---------|--------------------|----------|----------|-----------|---------|
| BMSR6BL | Overall Dimensions | 660 | 315 | 270 | £150.17 |
| | 2 Drawers | 573 | 262 | 50 | |
| | 1 Drawer | 573 | 262 | 75 | |



- Heavy duty construction designed for heavy use
- Heavy duty ball bearing drawer slides
- Powder coat finish – for improved corrosion resistance
- Double wall construction – for increased strength and reliability
- Drawer liners included

8 Drawer Mid Section

| Ref. | Description | Width mm | Depth mm | Height mm | List £ |
|-------|--------------------|----------|----------|-----------|---------|
| BMSR8 | Overall Dimensions | 1058 | 470 | 440 | £618.72 |
| | 4 Drawers | 569 | 412 | 75 | |
| | 4 Drawer | 308 | 412 | 75 | |



- Powder coat finish – for improved corrosion resistance
- Easily attached to roller cabinet
- Dimensions : 430 x 90 x 90mm

Tool And Can Holder And Can Holder

| Ref. | Dimensions mm | List £ |
|------|---------------|--------|
| BCH1 | 430 x 90 x 90 | £22.83 |



- Powder coat finish – for improved corrosion resistance
- Can be folded down when not in use

Side Shelf

| Ref. | Description | Width mm | Depth mm | List £ |
|------|-------------|----------|----------|--------|
| BSH1 | Side Shelf | 405 | 434 | £30.03 |

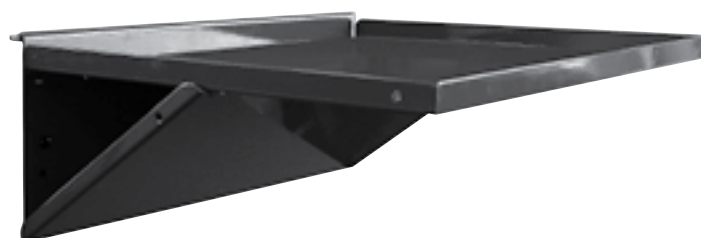

Side Shelf

| Ref. | Description | Width mm | Depth mm | List £ |
|--------|-------------|----------|----------|--------|
| BSH1BL | Side Shelf | 405 | 434 | £30.03 |



BRKIT80



8 Drawer Tool Chest and 76 Piece Toolkit

| Ref. | Contents | List £ |
|---------|--|---------|
| BRKIT80 | <ul style="list-style-type: none"> • 8 Drawer tool chest (BTBR8) • 60 Piece 3/8" SD metric socket set (748261) • 7 Piece metric combination wrench set (ND336T) • 16oz Ball pein hammer (BPH16) • 8 Piece Phillips & slotted screwdriver set (SDRIV4) | £448.55 |

BRKIT228



5 Drawer Roller Cabinet and 227 Piece Toolkit

| Ref. | Contents | List £ |
|----------|---|----------|
| BRKIT228 | <ul style="list-style-type: none"> • 5 Drawer roller cabinet with storage compartment (BRCR6) • 46 Piece 1/4" SD metric socket set (748254) • 26 Piece 1/2" SD metric socket set (748271) • Ratcheting screwdriver – with 6 piece bit set (BRSD2) • 12 piece metric ratcheting combination wrench set (RRJMSET1) • 12 Piece metric combination wrench set (ND349K) • 12" Adjustable wrench (312C) • 9 Piece ball ended metric hexagon socket set (HKMB9/C) • 16oz Ball pein hammer (BPH16) • 32oz Ball pein hammer (BPH32) • 8 Piece Phillips & slotted screwdriver set (SDRIV4) • Reversed bow hacksaw (HS212), 109 Piece insert bit set (BBS109) | £1078.80 |

BRKIT338

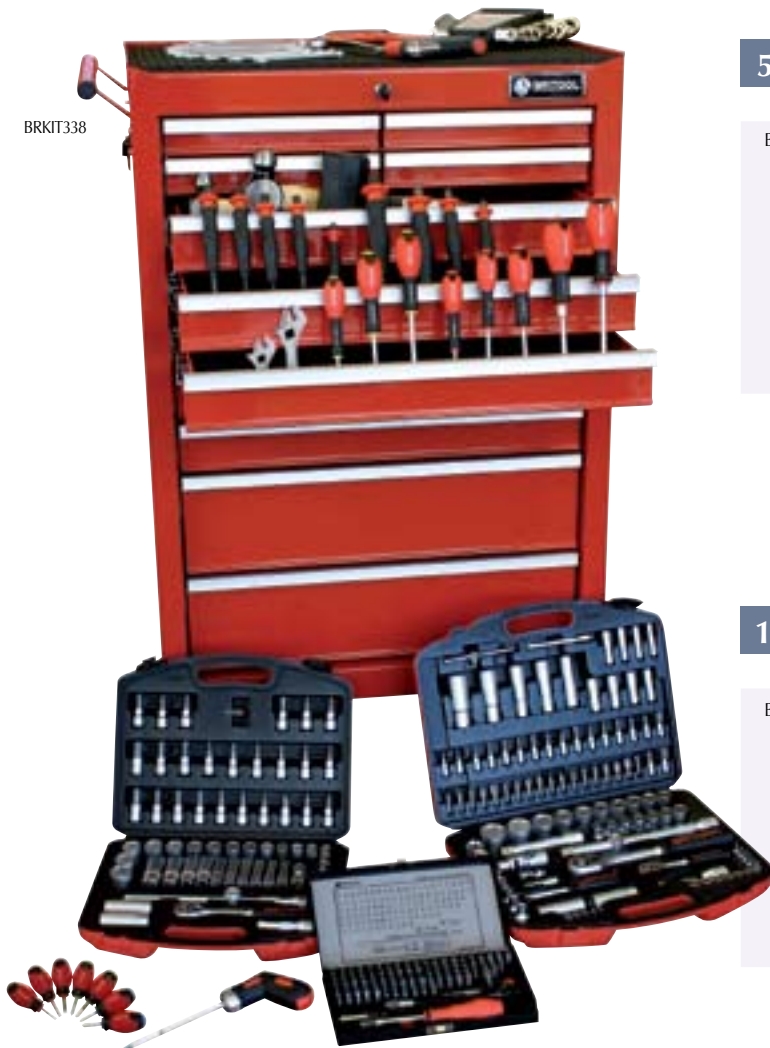

11 Drawer Roller Cabinet and 330 Piece Toolkit

| Ref. | Contents | List £ |
|----------|---|----------|
| BRKIT338 | <ul style="list-style-type: none"> • 11 Drawer roller cabinet (BRCR11) • 110 Piece 1/4" and 1/2" SD metric socket set (748291) • 60 Piece 3/8" SD metric socket set (748261) • 17 Piece metric combination wrench set (ND360E) • 12 Piece flexible ratcheting combination wrench set (RRFJMSET12) • 109 Piece insert bit set (BBS109) • Adjustable grip ratcheting screwdriver (BRSDF1) • 16 & 32oz Ball pein hammers (BPH16, BPH32) • 42oz Dead blow hammer (DBH42) • 8 Piece Phillips and slotted screwdriver set (SDRIV4) • 7 Piece stubby screwdriver set (SDRIV6) • 8" and 12" Adjustable wrenches (308C, 312C) | £1305.91 |



BRKIT314



BRKIT239

11 Drawer Roller Cabinet and 314 Piece Toolkit

| Ref. | Contents | List £ |
|----------|--|----------|
| BRKIT314 | <ul style="list-style-type: none"> • 11 Drawer roller cabinet (BRCR11) • 56 Piece 1/2" SD metric and AF socket set (748274) • 77 Piece 1/4" SD metric and AF socket set (748256) • 1/2" SD 600mm swivel handle (E86) • 17 Piece metric combination wrench set (ND360E) • 12 Piece metric flexible ratcheting combination wrench set (RRJMSET1) • 5 Piece metric double ended ratcheting wrench set (RRMSET5) • 109 Piece insert bit set (BBS109) • 3 Piece plier set (PLIER2) • Reversed bow hacksaw (HS212) • 8, 16 & 32oz Ball pein hammers (BPH8, 16, 32) • 9 Piece ball ended metric hexagon key set (HKMB9/C) • 8 Piece slotted and Phillips screwdriver set (SDRIV4) • 7 Piece tamper proof torx screwdriver set (SDRIV5) • 7 Piece stubby screwdriver set (SDRIV6) • 8", 12" and 15" Adjustable wrenches (308C, 312C, 315C) | £1470.57 |

3 Drawer Roller Cabinet and 237 Piece Toolkit

| Ref. | Contents | List £ |
|----------|--|---------|
| BRKIT239 | <ul style="list-style-type: none"> • 3 Drawer Roller Cabinet with storage compartment (BRCR3) • 60 Piece 3/8" SD metric socket set (748261) • 46 Piece 1/4" SD metric socket set (748254) • 12 Piece metric combination wrench set (ND349K) • 16oz Ball pein hammer (BPH16) • 8 Piece Phillips & slotted screwdriver set (SDRIV4, Reversed bow hacksaw (HS212) • 109 Piece insert bit set (BBS109) | £675.67 |



BRKIT447

11 Drawer Roller Cabinet and 447 Piece Toolkit

| Ref. | Contents | List £ |
|----------|--|----------|
| BRKIT447 | <ul style="list-style-type: none"> • 11 Drawer roller cabinet (BRCR11) • 56 Piece 1/2" SD metric and AF socket set (748274) • 88 Piece 3/8" SD metric and AF socket set (748267) • 77 Piece 1/4" SD metric and AF socket set (748256) • 1/2" SD 600mm swivel handle (E86) • 17 Piece metric combination wrench set (ND360E) • 10 Piece AF combination wrench set (ND243L) • 10 Piece extra long metric combination wrench set (RJXM10/S) • 12 Piece metric flexible ratcheting combination wrench set (RRF)MSET12) • 5 Piece metric double ended ratcheting wrench set (RRMSET5) • 109 Piece insert bit set (BBS109) • 3 Piece plier set (PLIER2) • Reversed bow hacksaw (HS212) • 8, 16 & 32oz Ball pein hammers (BPH8, 16, 32) • 9 Piece ball ended metric hexagon key set (HKMB9/C) • 8 Piece slotted and Phillips screwdriver set (SDRIV4) • 7 Piece tamper proof torx screwdriver set (SDRIV5) • 7 Piece stubby screwdriver set (SDRIV6) • 18 Piece stubby ratcheting screwdriver set BRSDSET2) • 8", 12" and 15" Adjustable wrenches (308C, 312C, 315C) • 3 Piece screwdriver handled pry bar set (SPBSET) | £1873.70 |



BRKIT470

BRKIT470

16 Drawer Tool Cart and 470 Piece Toolkit

| Ref. | Contents | List £ |
|----------|---|----------|
| BRKIT470 | <p>• 11 Drawer roller cabinet (BTCR16) • 56 Piece 1/2" SD metric and AF socket set (748274) • 88 Piece 3/8" SD metric and AF socket set (748267) • 77 Piece 1/4" SD metric and AF socket set (748256) • 1/2" SD 600mm swivel handle (E86) • 17 Piece metric combination wrench set (ND360E) • 10 Piece AF combination wrench set (ND243L) • 10 Piece extra long metric combination wrench set (RJXM10/S) • 10 Piece metric ring wrench set (NC389N) • 10 Piece metric open jaw wrench set (S2JM10) • 12 Piece metric flexible ratcheting combination wrench set (RRJMSET1) • 5 Piece metric double ended ratcheting wrench set (RRMSET5) • 109 Piece insert bit set (BBS109) • 3 Piece plier set (PLIER2) • Reversed bow hacksaw (HS212) • 8, 16 & 32oz Ball pein hammers (BPH8, 16, 32) • 9 Piece ball ended metric hexagon key set (HKMB9/C) • 8 Piece slotted and Phillips screwdriver set (SDRIV4) • 7 Piece tamper proof torx screwdriver set (SDRIV5) • 7 Piece stubby screwdriver set (SDRIV6) • 18 Piece stubby ratcheting screwdriver set BRSDSET2) • 8", 12" and 15" Adjustable wrenches (308C, 312C, 315C) • 3 Piece screwdriver handled pry bar set (SPBSET) • Lock grip pliers – 190mm curved jaw and 235mm straight jaw (PM900 & PM903)</p> | £2492.59 |

- Pro quality utility boxes
- Strong carrying handle
- Toggle catches for security

CTB45

Cantilever Tool Boxes

| Ref. | Description | Width mm | Depth mm | Height mm | kg | List £ |
|-------|---------------------|----------|----------|-----------|----|--------|
| CTB45 | Cantilever Tool Box | 450 | 210 | 205 | 4 | £29.94 |



Socketry



Specification

Britool sockets and accessories are manufactured from the highest quality materials using the latest techniques. All areas of the production process are subject to the highest quality control standards.

All Britool sockets and accessories should meet the highest performance expectations and are manufactured to the latest international standards.

Innovative features have been incorporated into product design wherever possible in order to give the greatest levels of functionality and ensure optimum performance.



Stress Relief Drive

Britool's advanced socket profile configuration increases the contact area between the socket and the fastener, minimising stress, and reducing the chance of damage to the fastener.

The load is applied to the fastener's flat edge rather than the corners: even if the fastener is already damaged, performance will be superior to that of a standard-profile socket.

Conventional Profile

Corner point contact gives high stress areas – highlights show contact points on the corner of the fastener

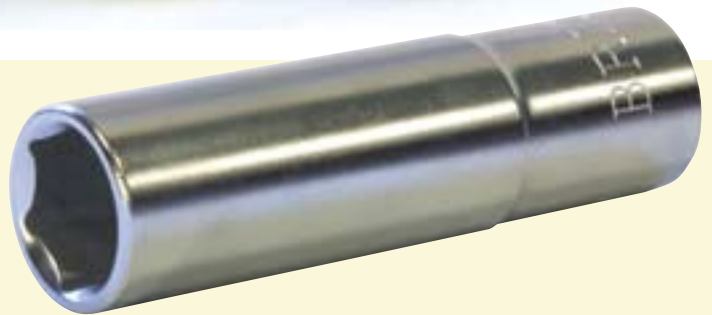
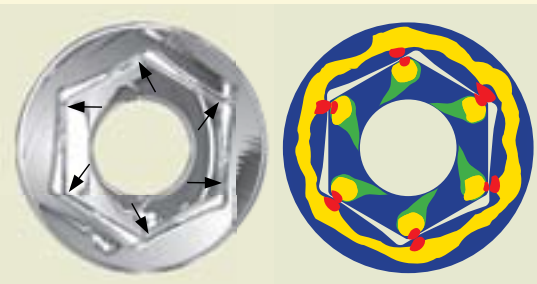

SRD Profile

Distributed surface loads relieves possible stress area – highlights show contact points away from the corner of the fastener

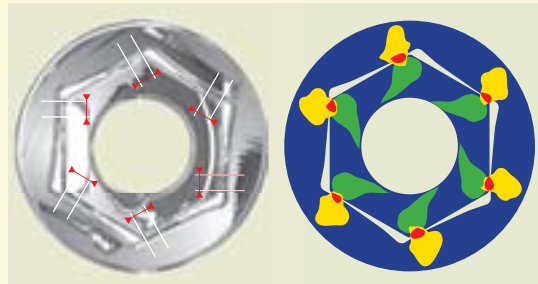

Forging Technology

Where possible, Britool products are forged from a single piece of steel, using the most appropriate technology.

The best forging solution gives the most uniform, linear grain flow—only this will give the highest levels of strength and durability.

This can be compared to the grain flow in wood—a shape with uninterrupted grain, grown into a shape, will always be stronger than one that has been cut, and liable to split across the grain.

To achieve high levels of grain flow uniformity, Britool uses several different methods dependent on the shape required—traditional drop forging, upset forging and cold forging.



Ratchets

In order to offer outstanding choice and ensure that the correct tool is always available, Britool offers a variety of ratchet styles and mechanisms:

Lever Reversible Ratchet

This extremely strong mechanism is available in 1/4", 3/8" and 1/2" drive. The 72 tooth design offers a minimum working arc of 5°. The mechanism is extremely smooth, and gives an almost negligible reverse torque—removing the risk of accidentally undoing the fastener on the reverse stroke. The twin pawl mechanism of this ratchet uses a different pawl for each direction of travel. This means that each is ideally positioned to take the greatest possible load—making it almost impossible to overload this ratchet design in normal use. Thumb lever controlled reversible action.



Clutch Ratchet

A highly innovative, simple, robust design, this roller bearing mechanism is available in 1/4", 3/8" and 1/2" square drive. The toothless nature of this ratchet gives a silent and smooth action with a minimum working arc of less than 1°—this is the ultimate ratchet for use where access is restricted. The design features a push through square drive to change direction.

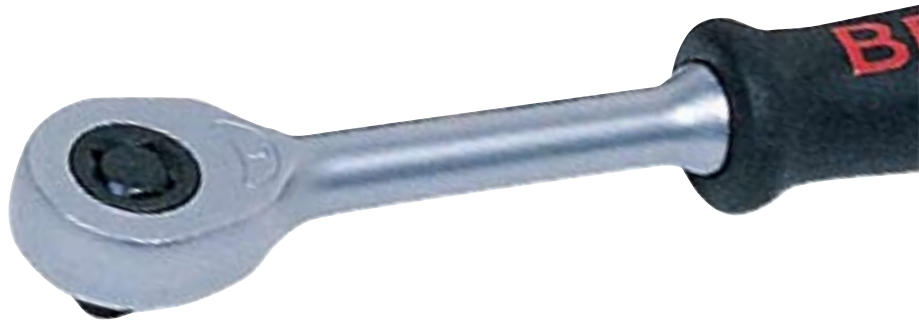

Swivel Head Ratchet

This ratchet design is available in 1/4", 3/8" and 1/2" square drive. It features a 72 tooth mechanism – offering a minimum working arc of 5°. Despite its compact size, the mechanism offers extremely good load characteristics – 17 teeth are engaged during loading, giving 45% more strength than most conventional ratchets. The swivel head design offers unrivalled access.



Flexi-Head Ratchet

Available in 3/8" and 1/2", this high strength design features the same mechanism as the lever reversible ratchet, coupled with a long handle and a flexible head – giving great access characteristics and allowing high torque loads.



Lock-on Quick Release Mechanism

The lever-reversible ratchet design is also available with a quick release mechanism which locks the socket in place, making accidental loss of the socket virtually impossible.

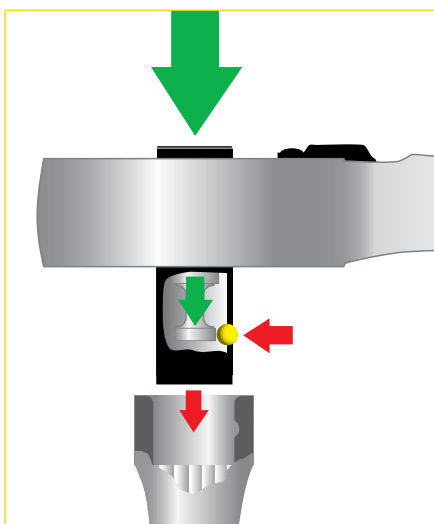

1/4" Square Drive Accessories



D46

1/4" SD Lock-On Reversible Ratchet

| Ref | Description | List £ |
|-----|---|--------|
| D46 | Polypropylene handle – resistant to hydrocarbons, 72 Tooth mechanism - 5° minimum working arc, Lock-On design, Thumb reversible | £32.81 |



1/4" SD Clutch Ratchet

| Ref | Description | List £ |
|-----|--|--------|
| D77 | Polypropylene handle – resistant to hydrocarbons, Roller bearing mechanism, Push-thru reversible mechanism, Thumb reversible | £36.67 |



1/4" SD Swivel Headed Reversible Ratchet

| Ref | Description | List £ |
|-------|---|--------|
| DFS20 | Polypropylene handle – resistant to hydrocarbons, 72 Tooth mechanism - 5° minimum working arc, Swivel head design for improved access | £28.39 |

Bit Holders

| Ref. | [F] Hex AF | [M] Hex AF | Length mm | List £ |
|-------|------------|------------|-----------|--------|
| D1UBA | 1/4" | 1/4" | 22 | £6.93 |



1/4" SD Sliding T Handle

| Ref | Description | List £ |
|-----|-------------------------|--------|
| D70 | Manufactured to DIN3122 | £10.90 |



1/4" SD Universal Joint

| Ref | Description | List £ |
|-----|---|--------|
| D91 | High strength design, Manufactured to DIN3123 | £20.27 |



DSAP

1/4" SD Female – 3/8" SD Male Converter

| Ref | Description | List £ |
|------|--|--------|
| DSAP | Used to drive 3/8" accessories using a 1/4" input, Manufactured to DIN3123 | £8.15 |



DPAS

3/8" SD Female – 1/4" SD Male Converter

| Ref | Description | List £ |
|------|--|--------|
| DPAS | Used to drive 1/4" accessories using a 3/8" input, Manufactured to DIN3123 | £10.95 |

3 Piece 1/4" Square Drive Extension Bar Set

| Ref | Description | List £ |
|--------|---|--------|
| 708510 | 3 1/4" SD Extension bars 50mm, 75mm and 150mm | £7.38 |



1/4" Square Drive Socketry



3 Piece 1/4" Square Drive Metric Socket Sets

| Ref | Contents | List £ |
|--------|---|--------|
| 708275 | 3 1/4" SD Cold forged metric hexagon sockets 4, 4.5, 5mm | £5.62 |
| 708280 | 3 1/4" SD Cold forged metric hexagon sockets 5.5, 6, 7mm | £5.62 |
| 708290 | 3 1/4" SD Cold forged metric hexagon sockets 8, 9, 10mm | £5.62 |
| 708300 | 3 1/4" SD Cold forged metric hexagon sockets 11, 12, 13mm | £5.62 |



13 Piece 1/4" Square Drive Metric Socket Set

| Ref | Contents | List £ |
|--------|---|--------|
| 708010 | 13 1/4" SD Cold forged metric hexagon sockets 4, 4.5, 5, 5.5, 6, 7, 8, 9, 10, 11, 12, 13, 14mm | £21.58 |



9 Piece 1/4" Square Drive AF Socket Set

| Ref | ContentsList | £ |
|--------|---|--------|
| 708020 | 9 1/4" SD Cold forged AF hexagon sockets 3/16, 7/32, 1/4, 9/32, 5/16, 11/32, 3/8, 7/16, 1/2" | £17.03 |



10 Piece 1/4" Square Drive Deep Metric Socket Set

| Ref | Contents | List £ |
|--------|--|--------|
| 708030 | 10 1/4" SD Cold forged deep metric hexagon sockets 5, 5.5, 6, 7, 8, 9, 10, 11, 12, 13mm | £20.44 |



8 Piece 1/4" Square Drive Hexagon Bit Socket Set

| Ref. | Contents | List £ |
|--------|--|--------|
| 708040 | 8 Hexagon bit sockets 2, 2.5, 3, 4, 5, 6, 7, 8mm | £13.63 |



18 Piece 1/4" Square Drive Metric Socket Set

| Ref | Contents | List £ |
|--------|--|--------|
| 748251 | <ul style="list-style-type: none"> 1/4" SD Quick release ratchet 13 1/4" SD Cold forged metric hexagon sockets 4, 4.5, 5, 5.5, 6, 7, 8, 9, 10, 11, 12, 13, 14mm 2 1/4" SD Extension bars 50mm and 150mm 1/4" SD Universal joint 1/4" SD - 1/4" Hexagon drive bit holder | £36.34 |



27 Piece 1/4" Square Drive Metric and AF Socket Set

| Ref | ContentsList | £ |
|--------|--|--------|
| 748252 | <ul style="list-style-type: none"> 1/4" SD Quick release ratchet 13 1/4" SD Cold forged metric hexagon sockets 4, 4.5, 5, 5.5, 6, 7, 8, 9, 10, 11, 12, 13, 14mm 9 1/4" SD Cold forged AF hexagon sockets • 3/16, 7/32, 1/4, 9/32, 5/16, 11/32, 3/8, 7/16, 1/2", 2 1/4" SD Extension bars 50mm and 150mm 1/4" SD Universal joint 1/4" SD - 1/4" Hexagon drive bit holder | £55.64 |

1/4" Square Drive Socket Sets



46 Piece 1/4" Square Drive Metric Socket Set

| Ref | Contents | List £ |
|--------|--|--------|
| 748254 | <ul style="list-style-type: none"> • Quick release ratchet • 2 Extension Bars 50&100mm • Flexible Extension 150mm • Spinner Handle • Sliding T Handle • Universal joint • 1/4" Hex-1/4" Square Adapter • 4 Hexagon Keys 1.3, 1.5, 2, 2.5mm • 13 Metric Sockets 4, 4.5, 5, 5.5, 6, 7, 8, 9, 10, 11, 12, 13, 14mm • 6 Torx Bit Sockets T10, 15, 20, 25, 30, 40 • 6 Hexagon Bit Sockets 3, 4, 5, 6, 7, 8mm • 3 Slotted Screwdriver Bits 4, 5.5, 7mm • 3 Pozidriv Bit Sockets PZ1, 2, 3 • 3 Phillips Bit Sockets, PH1, 2, 3 | £62.46 |

58 Piece 1/4" Square Drive Metric Socket Set

| Ref | Contents | List £ |
|--------|--|--------|
| 748255 | <ul style="list-style-type: none"> • 1/4" SD Quick release ratchet • 13 1/4" SD Cold forged metric hexagon sockets 4, 4.5, 5, 5.5, 6, 7, 8, 9, 10, 11, 12, 13, 14mm • 10 1/4" SD Cold forged deep metric hexagon sockets 5, 5.5, 6, 7, 8, 9, 10, 11, 12, 13mm • 1/4" SD Wobble extension bar 50mm • 2 1/4" SD Extension bars 100mm and 150mm • 1/4" SD Flexible extension bar 150mm • 1/4" SD Sliding T handle • 1/4" SD Universal joint • 1/4" SD - 1/4" Hexagon drive bit holder • 1/4" SD Female - 3/8" SD Male drive adapter • 1/4" Hexagon drive ratcheting screwdriver • 4 1/4" Hexagon drive slotted screwdriver bits 4, 4.5, 6.5, 8mm • 3 1/4" Hexagon drive Phillips® screwdriver bits Ph1, 2, 3 • 3 1/4" Hexagon drive Pozidriv® screwdriver bits Pz1, 2, 3 • 6 1/4" Hexagon drive tamper proof Torx® screwdriver bits T10, 15, 20, 25, 30, 40 • 5 1/4" Hexagon drive metric hexagon screwdriver bits 2, 3, 4, 5, 6mm • 3 1/4" Hexagon drive AF hexagon screwdriver bits 1/8, 3/16, 1/4" | £73.81 |

77 Piece 1/4" Square Drive Metric, AF and Torx Socket Set

| Ref | Contents | List £ |
|--------|---|--------|
| 748256 | <ul style="list-style-type: none"> • 1/4" SD Quick release ratchet • 13 1/4" SD Cold forged metric hexagon sockets 4, 4.5, 5, 5.5, 6, 7, 8, 9, 10, 11, 12, 13, 14mm • 10 1/4" SD Cold forged deep metric hexagon sockets 5, 5.5, 6, 7, 8, 9, 10, 11, 12, 13mm • 9 1/4" SD Cold forged AF hexagon sockets 3/16, 7/32, 1/4, 9/32, 5/16, 11/32, 3/8, 7/16, 1/2" • 5 1/4" SD Cold forged deep AF hexagon sockets 3/16, 1/4, 5/16, 3/8, 1/2" • 6 1/4" SD Female Torx® sockets T4, 5, 6, 7, 8, 10 • 1/4" SD Wobble extension bar 50mm • 2 1/4" SD Extension bars 100mm and 150mm • 1/4" SD Flexible extension bar 150mm • 1/4" SD Sliding T handle • 1/4" SD Universal joint • 1/4" SD - 1/4" Hexagon drive bit holder • 1/4" SD Female - 3/8" SD Male drive adapter • 1/4" Hexagon drive ratcheting screwdriver • 4 1/4" Hexagon drive slotted screwdriver bits 4, 4.5, 6.5, 8mm • 3 1/4" Hexagon drive Phillips® screwdriver bits Ph1, 2, 3 • 3 1/4" Hexagon drive Pozidriv® screwdriver bits Pz1, 2, 3 • 6 1/4" Hexagon drive tamper proof Torx® screwdriver bits T10, 15, 20, 25, 30, 40 • 5 1/4" Hexagon drive metric hexagon screwdriver bits 2, 3, 4, 5, 6mm • 3 1/4" Hexagon drive AF hexagon screwdriver bits 1/8, 3/16, 1/4" | £90.85 |





3/8" Square Drive Ratchets

| Ref | Description | List £ |
|-----|--|--------|
| A45 | Polypropylene handle – resistant to hydrocarbons, 72 Tooth mechanism- 5° minimum working arc, Thumb reversible | £38.53 |
| A46 | Polypropylene handle – resistant to hydrocarbons, 72 Tooth mechanism- 5° minimum working arc, Lock-On design, Thumb reversible | £47.84 |



3/8" SD Clutch Ratchet

| Ref | Description | List £ |
|-----|--|--------|
| A77 | Polypropylene handle – resistant to hydrocarbons, Roller bearing mechanism, Push-thru reversible mechanism, Thumb reversible | £43.00 |



3/8" Square Drive Flexible Headed Ratchet

| Ref | Description | List £ |
|------|--|--------|
| AF45 | 72 Tooth high strength twin pawl mechanism, Polypropylene handle – resistant to hydrocarbons, Flexible head for increased access | £41.96 |



3/8" SD Swivel Headed Reversible Ratchet

| Ref | Description | List £ |
|-------|---|--------|
| AFS20 | Polypropylene handle – resistant to hydrocarbons, 72 Tooth mechanism - 5° minimum working arc, Swivel head design for improved access | £38.61 |

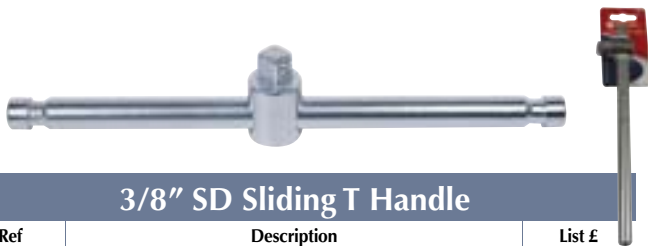

3/8" SD Sliding T Handle

| Ref | Description | List £ |
|-----|-------------------------|--------|
| A70 | Manufactured to DIN3122 | £12.92 |



3/8" SD Universal Joint

| Ref | Description | List £ |
|-----|---|--------|
| A91 | High strength design, Manufactured to DIN3123 | £20.89 |



3/8" SD Female – 1/2" SD Male Converter

| Ref | Description | List £ |
|------|--|--------|
| ASEP | Used to drive 1/2" accessories using a 3/8" input, Manufactured to DIN3123 | £8.23 |



1/2" SD Female – 3/8" SD Male Converter

| Ref | Description | List £ |
|------|--|--------|
| APES | Used to drive 3/8" accessories using a 1/2" input, Manufactured to DIN3123 | £8.09 |



3/8" SD Socket Clips

| Ref | Description | List £ |
|---------|---|--------|
| CLIPA/2 | Plastic clips to be used with rail PR250 or PR450 (See page 24) | £0.23 |



3 Piece 3/8" Square Drive Extension Bar Set

| Ref | Description | List £ |
|--------|--|--------|
| 708520 | 3 3/8" SD Extension bars 75mm, 150mm and 250mm | £9.65 |

Bit Holders

| Ref. | [F] Hex AF | [M] Hex AF | Length mm | List £ |
|-------|------------|------------|-----------|--------|
| A1UBA | 3/8" | 1/4" | 28 | £7.45 |



3/8" Square Drive Socket Sets



3 Piece 3/8" Square Drive Socket Sets

| Ref | Contents | List £ |
|--------|---|--------|
| 708310 | 3 3/8" SD Cold forged metric hexagon sockets 6, 7, 8mm | £6.76 |
| 708320 | 3 3/8" SD Cold forged metric hexagon sockets 9, 10, 11mm | £6.76 |
| 708330 | 3 3/8" SD Cold forged metric hexagon sockets 12, 13, 14mm | £6.76 |
| 708340 | 3 3/8" SD Cold forged metric hexagon sockets 15, 16, 17mm | £6.76 |
| 708350 | 3 3/8" SD Cold forged metric hexagon sockets 18, 19, 21mm | £6.76 |



14 Piece 3/8" Square Drive Metric Socket Set

| Ref | Contents | List £ |
|--------|--|--------|
| 708110 | 14 3/8" SD Cold forged metric hexagon sockets 6, 7, 8, 9, 10, 11, 12, 13, 14, 15, 16, 17, 18, 19mm | £22.71 |



13 Piece 3/8" Square Drive AF Socket Set

| Ref | Contents | List £ |
|--------|---|--------|
| 708120 | 13 3/8" SD Cold forged AF hexagon sockets 1/4, 5/16, 11/32, 3/8, 7/16, 1/2, 9/16, 5/8, 11/16, 3/4, 13/16, 7/8, 1" | £21.58 |



15 Piece 3/8" Square Drive Deep Metric Socket Set

| Ref | Contents | List £ |
|--------|---|--------|
| 748262 | 15 3/8" SD Cold forged deep metric hexagon sockets 6, 7, 8, 9, 10, 11, 12, 13, 14, 15, 16, 17, 18, 19, 22mm | £36.34 |



7 Piece 3/8" Square Drive Metric Ball Ended Bit Socket Set

| Ref. | Contents | List £ |
|--------|--|--------|
| 708130 | 7 Ball ended hexagon metric bit sockets 3, 4, 5, 6, 7, 8, 10mm | £26.12 |



8 Piece 3/8" Square Drive Flexible Metric Socket Set

| Ref. | Contents | List £ |
|--------|---|--------|
| 708140 | 8 Flexible sockets 10, 11, 12, 13, 14, 15, 17, 19mm | £31.23 |



24 Piece 3/8" Square Drive Metric Socket Set

| Ref | Contents | List £ |
|--------|--|--------|
| 748263 | • 3/8" SD Quick release ratchet • 19 3/8" SD Cold forged metric hexagon sockets 6, 7, 8, 9, 10, 11, 12, 13, 14, 15, 16, 17, 18, 19, 20, 21, 22, 23, 24mm • 2 3/8" SD Extension bars 75mm and 125mm • 3/8" SD Universal joint • 3/8" SD - 1/4" Hexagon drive bit holder | £62.46 |



18 Piece 3/8" Square Drive AF Socket Set

| Ref | Contents | List £ |
|--------|---|--------|
| 748264 | <ul style="list-style-type: none"> • 3/8" SD Quick release ratchet • 13 3/8" SD Cold forged AF hexagon sockets 1/4, 5/16, 11/32, 3/8, 7/16, 1/2, 9/16, 5/8, 11/16, 3/4, 13/16, 7/8, 1" • 3/8" SD Wobble extension bar 75mm • 3/8" SD Extension bar 150mm • 3/8" SD Universal joint • 3/8" SD - 1/4" Hexagon drive bit holder | £51.10 |



60 Piece 3/8" Square Drive Metric Socket Set

| Ref | Contents | List £ |
|--------|--|---------|
| 748261 | <ul style="list-style-type: none"> • Quick release ratchet • 18 Cold forged metric hexagon sockets 6, 7, 8, 9, 10, 11, 12, 13, 14, 15, 16, 17, 18, 19, 20, 21, 22, 24mm • 10 Deep, cold forged metric hexagon sockets 8, 9, 10, 11, 12, 13, 14, 15, 17, 19mm • 75mm Extension bar • 250mm Extension bar / Sliding T handle • Universal joint • 2 Spark plug sockets 16, 21mm • 7 Hexagon bit sockets 3, 4, 5, 6, 7, 8, 10mm • 3 Slotted bit sockets 5.5, 7, 8mm • 9 Tamper proof torx bit sockets • 3 Pozidriv® bit sockets PZ1, 2, 3 • 3 Phillips® bit sockets PH1, 2, 3 | £113.50 |

88 Piece 3/8" Square Drive Metric, AF & Torx Socket Set

| Ref | Contents | List £ |
|--------|---|---------|
| 748267 | <ul style="list-style-type: none"> • 3/8" SD Quick release ratchet • 19 3/8" SD Cold forged metric hexagon sockets 6, 7, 8, 9, 10, 11, 12, 13, 14, 15, 16, 17, 18, 19, 20, 21, 22, 23, 24mm • 11 3/8" SD Cold forged deep metric hexagon sockets 8, 9, 10, 11, 12, 13, 14, 15, 16, 17, 19mm • 13 3/8" SD Cold forged AF hexagon sockets 1/4, 5/16, 11/32, 3/8, 7/16, 1/2, 9/16, 5/8, 11/16, 3/4, 13/16, 7/8, 1" • 7 3/8" SD Cold forged deep AF hexagon sockets 5/16, 3/8, 7/16, 1/2, 9/16, 11/16, 3/4" • 5 3/8" SD Female Torx® sockets T8, 10, 12, 14, 16 • 3/8" SD Wobble extension bar 75mm • 2 3/8" SD Extension bars 150mm and 250mm • 3/8" SD Sliding T handle • 3/8" SD Universal joint • 3/8" SD - 1/4" Hexagon drive bit holder • 3/8" SD Female - 1/4" SD Male drive adapter • 3/8" SD Female - 1/2" SD Male drive adapter • 4 1/4" Hexagon drive slotted screwdriver bits 4, 4.5, 6.5, 8mm • 3 1/4" Hexagon drive Phillips screwdriver bits Ph1, 2, 3 • 3 1/4" Hexagon drive Pozidriv screwdriver bits Pz1, 2, 3 • 6 1/4" Hexagon drive tamper proof Torx screwdriver bits T10, 15, 20, 25, 30, 40 • 5 1/4" Hexagon drive metric hexagon screwdriver bits 2, 3, 4, 5, 6mm • 3 1/4" Hexagon drive AF hexagon screwdriver bits 1/8, 3/16, 1/4" | £130.59 |

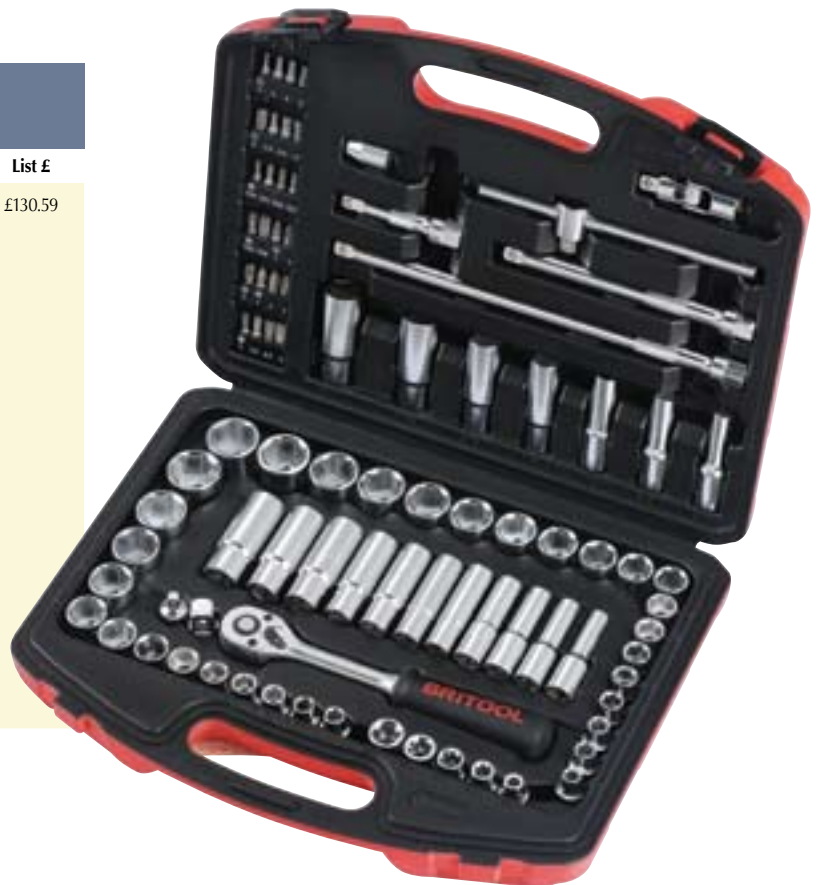

1/2" Square Drive Socketry



1/2" Square Drive Ratchet

| Ref | Description | List £ |
|-----|--|--------|
| E74 | Polypropylene handle – resistant to hydrocarbons, 72 Tooth mechanism- 5° minimum working arc, Thumb reversible | £42.89 |



1/2" Square Drive Lock-On Ratchet

| Ref | Description | List £ |
|-----|--|--------|
| E75 | Polypropylene handle – resistant to hydrocarbons, 72 Tooth mechanism- 5° minimum working arc, Lock-On design, Thumb reversible | £52.15 |



1/2" SD Clutch Ratchet

| Ref | Description | List £ |
|-----|--|--------|
| E77 | Polypropylene handle – resistant to hydrocarbons, Roller bearing mechanism, Push-thru reversible mechanism, Thumb reversible | £49.47 |



1/2" Square Drive Flexi Head Ratchet

| Ref | Description | List £ |
|------|--|--------|
| EF74 | 72 Tooth high strength twin pawl mechanism, Polypropylene handle – resistant to hydrocarbons, Flexible head for increased access | £59.15 |



1/2" SD Swivel Headed Reversible Ratchet

| Ref | Description | List £ |
|-------|---|--------|
| EFS20 | Polypropylene handle – resistant to hydrocarbons, 72 Tooth mechanism - 5° minimum working arc, Swivel head design for improved access | £43.15 |



1/2" SD 600mm Swivel Handle

| Ref | Description | List £ |
|-----|---|--------|
| E85 | Polypropylene handle – resistant to hydrocarbons, 460mm long for exceptional leverage | £35.26 |
| E86 | Polypropylene handle – resistant to hydrocarbons, 600mm long for exceptional leverage | £44.81 |



1/2" SD Sliding T Handle

| Ref | Description | List £ |
|-----|-------------------------|--------|
| E70 | Manufactured to DIN3122 | £17.69 |



1/2" SD Universal Joint

| Ref | Description | List £ |
|-----|---|--------|
| E91 | High strength design, Manufactured to DIN3123 | £21.94 |



1/2" SD Female – 3/4" SD Male Converter

| Ref | Description | List £ |
|------|--|--------|
| ESHF | Used to drive 3/4" accessories using a 1/2" input, Manufactured to DIN3123 | £12.04 |

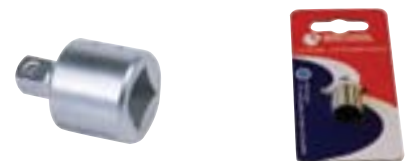

3/4" SD Female – 1/2" SD Male Converter

| Ref | Description | List £ |
|------|--|--------|
| EPHS | Used to drive 1/2" accessories using a 3/4" input, Manufactured to DIN3123 | £16.39 |



1/2" SD Socket Clips

| Ref | Description | List £ |
|---------|---|--------|
| CLIFE/2 | Plastic clips to be used with rail PR250 or PR450 | £0.23 |



Socket Rails

| Ref | Description | List £ |
|-------|--|--------|
| PR250 | Socket Rail 250mm - For use with CLIPA/2 or CLIFE/2 (See page 20 & 24) | £1.36 |
| PR450 | Socket Rail 450mm - For use with CLIPA/2 or CLIFE/2 (See page 20 & 24) | £5.68 |



3 Piece 1/2" Square Drive Extension Bar Set

| Ref | Contents | List £ |
|--------|--|--------|
| 708530 | 3 1/2" SD Extension bars 75mm, 125mm and 250mm | £12.49 |



3 Piece 1/2" Square Drive Sets

| Ref | Description | Contents | List £ |
|--------|---|---|--------|
| 708360 | 3 Piece 1/2" Square Drive Metric Socket Set | 3 1/2" SD Cold forged metric hexagon sockets 10, 11, 12mm | £7.89 |
| 708370 | 3 Piece 1/2" Square Drive Metric Socket Set | 3 1/2" SD Cold forged metric hexagon sockets 13, 14, 15mm | £7.89 |
| 708380 | 3 Piece 1/2" Square Drive Metric Socket Set | 3 1/2" SD Cold forged metric hexagon sockets 16, 17, 18mm | £7.89 |
| 708390 | 3 Piece 1/2" Square Drive Metric Socket Set | 3 1/2" SD Cold forged metric hexagon sockets 19, 21, 24mm | £8.46 |
| 708400 | 3 Piece 1/2" Square Drive Metric Socket Set | 3 1/2" SD Cold forged metric hexagon sockets 27, 30, 32mm | £11.30 |



10 Piece 1/2" Square Drive Metric Socket Set

| Ref | Contents | List £ |
|--------|--|--------|
| 708260 | 10 1/2" SD Cold forged metric hexagon sockets 10, 11, 12, 13, 14, 15, 16, 17, 18, 19mm | £21.58 |



16 Piece 1/2" Square Drive Metric Socket Set

| Ref | Contents | List £ |
|--------|--|--------|
| 708220 | 25 1/2" SD Cold forged metric hexagon sockets 10, 11, 12, 13, 14, 15, 16, 17, 18, 19, 21, 22, 24, 27, 30, 32mm | £39.75 |



15 Piece 1/2" Square Drive AF Socket Set

| Ref | Contents | List £ |
|--------|--|--------|
| 708230 | 15 1/2" SD Cold forged AF hexagon sockets 3/8, 7/16, 1/2, 9/16, 5/8, 11/16, 3/4, 13/16, 7/8, 15/16, 1, 1 1/16, 1 1/8, 1 3/16, 1 1/4" | £39.75 |



6 Piece 1/2" Square Drive Whitworth Socket Set

| Ref | Contents | List £ |
|--------|---|--------|
| 708270 | 6 1/2" SD Whitworth sockets 3/16, 1/4, 5/16, 3/8, 7/16, 1/2WW | £23.85 |



1/2" Square Drive Socket Sets



7 Piece 1/2" Square Drive Hexagon Bit Socket Set

| Ref. | Contents | List £ |
|--------|---|--------|
| 708240 | 7 Hexagon bit sockets 6, 7, 8, 10, 12, 14, 17mm | £24.98 |



14 Piece 1/2" Square Drive Deep Metric Socket Set

| Ref | Contents | List £ |
|--------|---|--------|
| 748275 | 14 1/2" SD Cold forged metric deep hexagon sockets 12, 13, 14, 15, 16, 17, 18, 19, 21, 22, 24, 27, 30, 32mm | £51.10 |



12 Piece 1/2" Square Drive Metric Bit Socket Set

| Ref. | Contents | List £ |
|--------|---|--------|
| 748276 | <ul style="list-style-type: none"> • 6 Metric bit sockets 4, 5, 6, 8, 10, 12mm • 6 Long reach metric bit sockets 4, 5, 6, 8, 10, 12mm | £32.93 |



16 Piece 1/2" Square Drive Torx® Socket Set

| Ref. | Contents | List £ |
|--------|---|--------|
| 748277 | <ul style="list-style-type: none"> • 9 Torx® bit sockets T20, 25, 27, 30, 40, 45, 50, 55, 60 • 7 Torx sockets E10, 12, 14, 16, 18, 20, 24 | £31.80 |



Socket stand
Ref. SOCKETSTAND



26 Piece 1/2" Square Drive Metric Socket Set

| Ref | Contents | List £ |
|--------|--|---------|
| 748271 | <ul style="list-style-type: none"> • Ratchet • 3 Extension Bars 75, 125 & 250mm • Universal Joint • Sliding T Adapter • 2 Spark Plug Sockets 16 & 21mm • 18 Metric Sockets 10, 11, 12, 13, 14, 15, 16, 17, 18, 19, 20, 21, 22, 23, 24, 27, 30, 32mm | £102.14 |

23 Piece 1/2" Square Drive AF Socket Set

| Ref | Contents | List £ |
|--------|--|---------|
| 748273 | <ul style="list-style-type: none"> • 1/2" SD Quick release ratchet • 17 1/2" SD Cold forged AF hexagon sockets 3/8, 7/16, 1/2, 9/16, 19/32, 5/8, 21/32, 11/16, 3/4, 13/16, 7/8, 15/16, 1, 1 1/16, 1 1/8, 1 3/16, 1 1/4" • 1/2" SD Wobble extension bar 75mm • 2 1/2" SD Extension bars 150mm and 250mm • 1/2" SD Sliding T handle • 1/2" SD Universal joint | £101.07 |



44 Piece 1/2" Square Drive Metric Socket Set

| Ref | Contents | List £ |
|--------|--|---------|
| 748272 | <ul style="list-style-type: none"> • 1/2" SD Quick release ratchet • 25 1/2" SD Cold forged metric hexagon sockets 8, 9, 10, 11, 12, 13, 14, 15, 16, 17, 18, 19, 20, 21, 22, 23, 24, 25, 26, 27, 28, 29, 30, 32, 34mm • 11 1/2" SD Cold forged deep metric hexagon sockets 12, 13, 14, 15, 16, 17, 18, 19, 21, 22, 24mm • 1/2" SD Wobble extension bar 75mm • 2 1/2" SD Extension bars 125mm and 250mm • 1/2" SD Sliding T handle • 1/2" SD Universal joint • 1/2" SD Female – 3/8" SD Male drive adapter • 3/8" SD Female – 1/2" SD Male drive adapter | £124.91 |

56 Piece 1/2" Square Drive Metric, AF & Torx Socket Set

| Ref | Contents | List £ |
|--------|---|---------|
| 748274 | <ul style="list-style-type: none"> • 1/2" SD Quick release ratchet • 25 1/2" SD Cold forged metric hexagon sockets 8, 9, 10, 11, 12, 13, 14, 15, 16, 17, 18, 19, 20, 21, 22, 23, 24, 25, 26, 27, 28, 29, 30, 32, 34mm • 15 1/2" SD Cold forged AF hexagon sockets 3/8, 7/16, 1/2, 9/16, 5/8, 11/16, 3/4, 13/16, 7/8, 15/16, 1, 1 1/16, 1 1/8, 1 3/16, 1 1/4" • 8 1/2" SD Cold forged Torx® sockets T10, 11, 12, 14, 16, 18, 20, 24 • 1/2" SD Wobble extension bar 75mm • 2 1/2" SD Extension bars 125mm and 250mm • 1/2" SD Sliding T handle • 1/2" SD Universal joint • 1/2" SD Female – 3/8" SD Male drive adapter • 3/8" SD Female – 1/2" SD Male drive adapter | £136.27 |



5 Piece 1/4" and 3/8" Square Drive Extension Bar Set

| Ref | Description | List £ |
|--------|---|--------|
| 708540 | <ul style="list-style-type: none"> • 2 1/4" SD Extension bars 50mm and 100mm • 3 3/8" SD Extension bars 75mm, 150mm and 250mm | £14.19 |



5 Piece 1/4" and 3/8" Square Drive Wobble Extension Bar Set

| Ref. | Description | List £ |
|--------|---|--------|
| 708550 | <ul style="list-style-type: none"> • 2 Wobble Extension bars 50mm and 100mm • 3 Wobble Extension bars 75mm, 150mm and 250mm | £15.90 |



13 Piece 1/4", 3/8" and 1/2" Square Drive Female Torx® Socket Set

| Ref | Description | List £ |
|--------|---|--------|
| 708430 | <ul style="list-style-type: none"> • 5 1/4" SD Female Torx® sockets E4, 5, 6, 7, 8 • 4 3/8" SD Female Torx® sockets E10, 12, 14, 16 • 4 1/2" SD Female Torx® sockets E18, 20, 22, 24 | £24.98 |

71 Piece 1/4" and 3/8" Square Drive Metric Socket Set

| Ref | Description | List £ |
|--------|---|---------|
| 748293 | <ul style="list-style-type: none"> • 1/4" SD Quick release ratchet • 13 1/4" SD Cold forged metric hexagon sockets 4, 4.5, 5, 5.5, 6, 7, 8, 9, 10, 11, 12, 13, 14mm • 9 1/4" SD Cold forged deep metric hexagon sockets 5, 6, 7, 8, 9, 10, 11, 12, 13mm • 5 1/4" SD Female Torx® sockets T4, 5, 6, 7, 8 • 2 1/4" SD Extension bars 50mm and 150mm • 1/4" SD Sliding T handle • 1/4" SD Universal joint • 1/4" SD – 1/4" Hexagon drive bit holder • 3/8" SD Quick release ratchet • 19 3/8" SD Cold forged metric hexagon sockets 6, 7, 8, 9, 10, 11, 12, 13, 14, 15, 16, 17, 18, 19, 20, 21, 22, 23, 24mm • 8 3/8" SD Cold forged deep metric hexagon sockets 13, 14, 15, 16, 17, 18, 19, 22mm • 4 3/8" SD Female Torx® sockets T10, 12, 14, 16 • 3 3/8" SD Extension bars 75, 125mm and 250mm • 3/8" SD Sliding T handle • 3/8" SD Universal joint • 3/8" SD – 1/4" Hexagon drive bit holder | £124.91 |



14 Piece 1/4" and 3/8" Square Drive Torx® Bit Socket Set

| Ref | Description | List £ |
|--------|---|--------|
| 708410 | <ul style="list-style-type: none"> • 10 1/4" SD Torx® bit sockets T6, 7, 8, 9, 10, 15, 20, 25, 27, 30 • 4 3/8" SD Torx® bit sockets T40, 45, 50, 55 | £32.93 |



9 Piece 1/4" and 3/8" Square Drive Hexagon Insert Bit Socket Set

| Ref | Description | List £ |
|--------|---|--------|
| 708420 | <ul style="list-style-type: none"> • 4 1/4" SD Hexagon bit sockets 3, 4, 5, 6mm • 5 3/8" SD Hexagon bit sockets 7, 8, 9, 10, 12mm | £23.85 |



110 Piece 1/2" and 1/4" Square Drive Metric Socket Set

| Ref | Description | List £ |
|--------|--|---------|
| 748291 | <p>1/2" Square Drive</p> <ul style="list-style-type: none"> • Quick release ratchet • 17 Cold forged metric hexagon sockets 10, 11, 12, 13, 14, 15, 16, 17, 18, 19, 20, 21, 24, 27, 30, 32mm • 5 Deep, cold forged metric hexagon sockets 14, 15, 17, 19, 22mm • 8 Female Torx® sockets T10, 11, 12, 14, 16, 18, 20, 24 • 125mm Extension bar • 250mm Extension bar / Sliding T handle • Universal joint • 2 Spark plug sockets 16, 21mm • 5/16" Hexagon Bit Holder <p>1/4" Square Drive</p> <ul style="list-style-type: none"> • Quick release ratchet • 13 Cold forged metric hexagon sockets 4, 4.5, 5, 5.5, 6, 7, 8, 9, 10, 11, 12, 13, 14mm • 8 Deep, cold forged metric hexagon sockets 6, 7, 8, 9, 10, 11, 12, 13mm • 5 Female Torx® sockets T4, 5, 6, 7, 8 • 50mm Extension bar • 100mm Extension bar • Sliding T handle • Universal joint • Spinner handle • 7 Torx® bit sockets T8, 10, 15, 20, 25, 27, 30 • 3 Slotted screwdriver bits 4, 5.5, 6.5mm • 4 Hexagon bit sockets 3, 4, 5, 6mm • 2 Pozidriv® bit sockets PZ 1, 2 • 2 Phillips® bit sockets PH 1, 2 • 4 Hexagon Keys 1.27, 1.5, 2, 2.5mm • Hexagon Insert Bits • 5 Torx® insert bits T40, 45, 50, 55, 60 • 2 Phillips® insert bits PH3, 4 • 2 Pozidriv® insert bits PZ3, 4 • 7 Torx® bit sockets T8, 10, 15, 20, 25, 27, 30 • 3 Slotted insert bits 8, 10, 12mm • 5 Hexagon insert bits 7, 8, 10, 12, 14mm • 1/4" Hexagon / 1/4" SD adapter | £157.84 |



3/4" Square Drive Socketry



3/4" Square Drive Ratchet

| Ref | Description | List £ |
|-----|------------------|---------|
| H74 | Lever reversible | £158.04 |



3/4" Square Drive Sliding T Handle

| Ref | Description | List £ |
|-----|-------------------------|--------|
| H70 | Manufactured to DIN3122 | £41.33 |



21 Piece 3/4" Square Drive Metric Socket Set

| Ref | Description | List £ |
|--------|--|---------|
| 748289 | <ul style="list-style-type: none"> • Ratchet • 3 Extension Bars 75, 125 & 250mm • Sliding T Handle • 16 Metric Hexagon Sockets 19, 21, 22, 23, 24, 26, 27, 29, 30, 32, 35, 36, 38, 41, 46, 50mm | £261.18 |

Specification

Designed to exacting standards and manufactured from the highest quality alloy steel, Britool impact sockets are heat treated to ensure that they conform to the highest standards of reliability and durability.

Britool impact sockets are suitable for use with all air and power tools.

All Britool impact sockets incorporate Stress Relief Drive, increasing the maximum applicable torque and reducing fastener damage.

Manufactured to ISO 1174-2

WARNING!

Do not use chrome finished sockets on impact and power tools.



9 Piece 3/8" Square Drive Metric Impact Socket Set

| Ref | Description | List £ |
|--------|--|--------|
| 758200 | 9 3/8" SD Cold forged metric hexagon impact sockets 8, 9, 10, 11, 12, 13, 14, 17, 19mm | £21.58 |



17 Piece 1/2" Square Drive Metric Impact Socket Set

| Ref | Description | List £ |
|--------|--|--------|
| 758300 | <ul style="list-style-type: none"> • 16 1/2" SD Cold forged metric hexagon impact sockets 10, 11, 12, 13, 14, 15, 16, 17, 18, 19, 21, 22, 24, 27, 30, 32mm • 125mm Impact extension bar • Locking pins and rings | £67.00 |



14 Piece 1/2" Square Drive Deep Metric Impact Socket Set

| Ref | Description | List £ |
|--------|--|--------|
| 758500 | <ul style="list-style-type: none"> • 14 1/2" SD Cold forged deep metric hexagon impact sockets 10, 11, 12, 13, 14, 16, 17, 19, 21, 22, 24, 27, 30, 32mm • Locking pins and rings | £78.35 |

Torque Wrenches



The torque wrench is an essential hand tool that is now fundamental in all garages and workshops.

The Britool torque wrench range has been carefully designed to provide a range of solutions to meet the needs of the torque-tightening user.

What is Torque ?

- Torque is a turning or twisting force, the result of a force applied at a given distance about a known centre
- It is recorded in units of force x distance

i.e. **Nm = Newtons (force) x metres (distance) or**

lbf/ft = lbf (force) x feet (distance) (1 Newton = 1kg m/s²)

Classic Mechanical Torque Wrenches

The Britool Classic torque wrench has won a reputation for reliability and quality established over 50 years. The unique mechanism has distinct advantages which ensure it remains a firm favourite with users worldwide.

Unique 3-phase Mechanism

A progressive torque build-up to the selected setting is easily detected by three clear signals:

- 1 **SIGHT** see the mechanism progressively move towards the point of break as the load is applied
- 2 **TOUCH** feel the point of torque
- 3 **SOUND** unmistakable **CLICK**
This makes it ideal for use in noisy environments

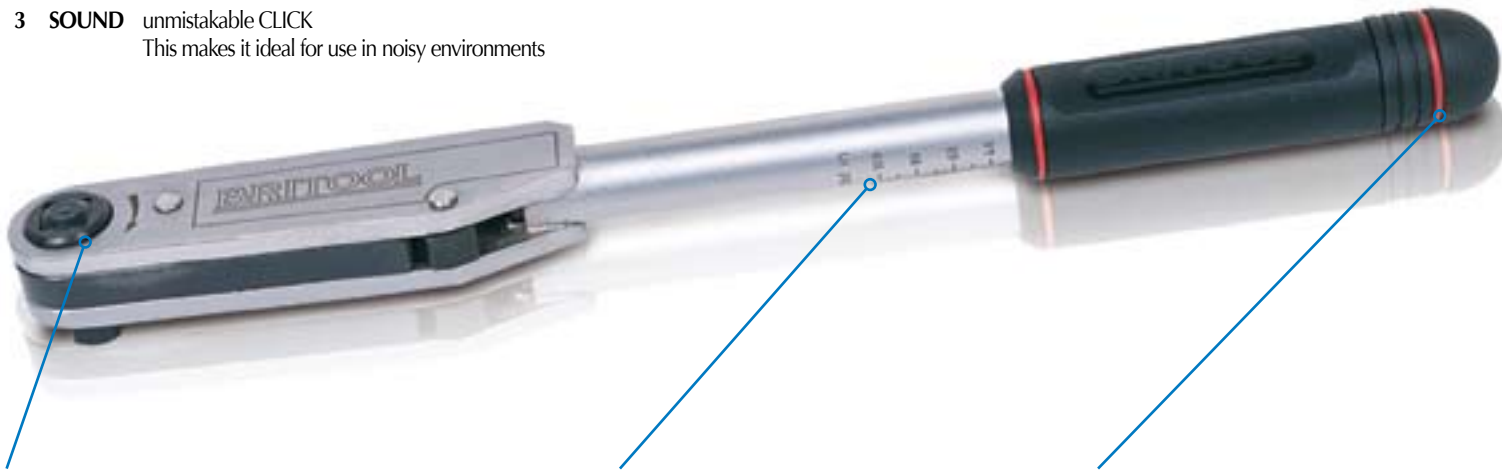
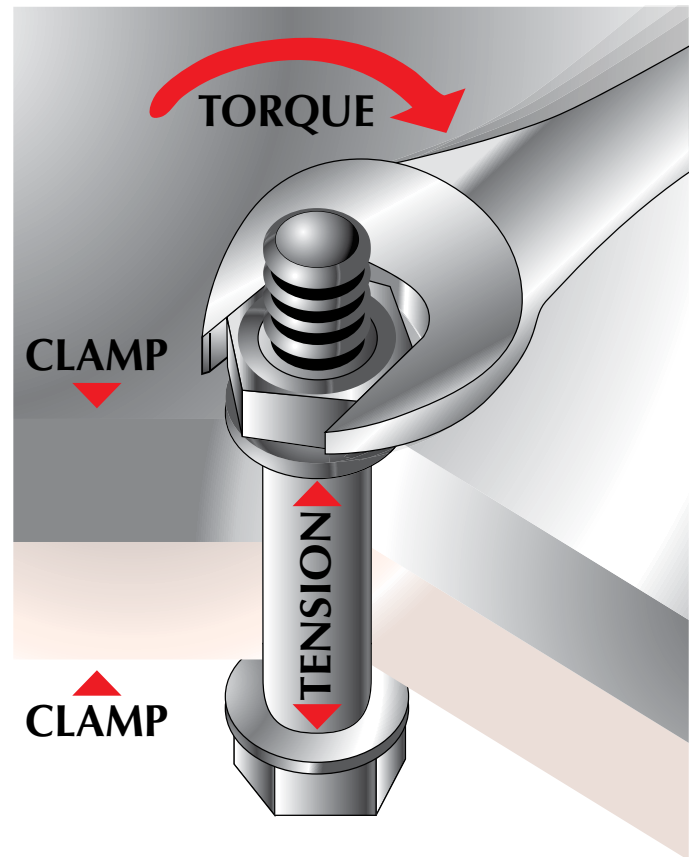

ACCESSIBILITY

Compact design ideal for restricted access

DURABILITY

Proven to be one of the most robust products in the market, the first choice for arduous conditions

ACCURACY

Exceeds requirements of ISO 6789

SCALE

Multiple scales – Nm, kg.m, lbf.in and lbf.ft are branded into steel tube, giving readability for the life of the product

FLEXIBILITY

Push-through square drive for left and right hand operation

SETTING

Retractable adjuster knob cannot be altered by accident

SERVICE

Fully repairable with dedicated service kits

Classic Mechanical Torque Wrench – Non-Length Dependant

Unlike most other torque wrenches, the mechanism pivots around the square drive. This gives the major advantage in that the torque wrench is not length dependant. As a result there is no variation to the application of the preset torque value, no matter where the handle is grasped.

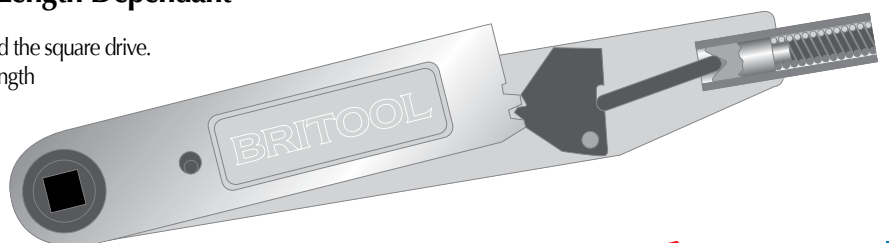

Classic Torque Wrench Ranges

| Ref. | Square drive | N.m | | | | | | | | | | | | | | |
|----------|--------------|-----|---|----|----|----|----|----|-----|-----|-----|-----|-----|-----|-----|-----|
| | | 2.5 | 5 | 10 | 20 | 33 | 50 | 70 | 100 | 135 | 200 | 225 | 300 | 330 | 480 | 720 |
| AVT100A | 3/8 | ■ | | | | | | | | | | | | | | |
| AVT300A | | ■ | | | | | | | | | | | | | | |
| AVT600 | | ■ | | | | | | | | | | | | | | |
| EVT600A | 1/2 | ■ | | | | | | | | | | | | | | |
| EVT1200A | | ■ | | | | | | | | | | | | | | |
| EVT2000A | | ■ | | | | | | | | | | | | | | |
| EVT3000A | | ■ | | | | | | | | | | | | | | |
| HVT5000 | 3/4 | ■ | | | | | | | | | | | | | | |
| HVT7200 | | ■ | | | | | | | | | | | | | | |
| GVT8400 | 1 | ■ | | | | | | | | | | | | | | |

Scale Divisions

| Series | N.m | Kg.m | lbf.in | lbf.ft |
|--------|------|------|--------|--------|
| 100 | 0.5 | 0.1 | 10.0 | 1.0 |
| 300 | 1.0 | 0.1 | 10.0 | 1.0 |
| 600 | 2.0 | 0.2 | 20.0 | 2.0 |
| 1200 | 5.0 | 1.0 | 50.0 | 2.0 |
| 2000 | 5.0 | 1.0 | 50.0 | 2.0 |
| 3000 | 10.0 | 1.0 | 100.0 | 10.0 |
| 5000 | 10.0 | - | 100.0 | 10.0 |
| 8400 | 10.0 | - | - | 10.0 |

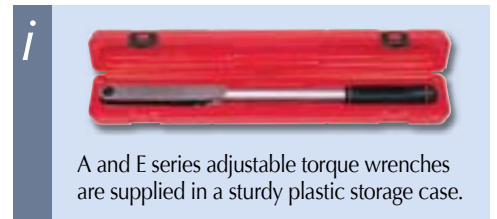

GVT8400

HVT7200

HVT5000



How To Read The Britool Torque Wrench Code

| Square drive size inches | Regular type | Torque Wrench | Maximum lbf.in | Scale type |
|---|-------------------------------------|---------------|----------------|---|
| E | V | T | 3000 | A |
| Aero 3/8 Engineers 1/2 Heavy 3/4 Giant 1 | Variable (regular, adjustable type) | | | A denotes a production change to the latest model |

The example code in the blue band is for a 1/2" variable torque wrench, maximum 3000 lbf.in

Torque Measurement Conversion Chart

| TO CONVERT FROM | TO CONVERT TO | | | | | | | | |
|-----------------|---------------------------|---------------------------|---------------------|---------------------------|------------------------|------------------|---------------------|---------------------|---------------------|
| | mN.m millinewton-metre | cN.m centinewton-metre | N.m newton-metre | daN.m decanewton-metre | cm.kg centimetre-kg | m.kg metre-kg | in.oz inch-ounce | in.lb inch-pound | ft.lb foot-pound |
| 1mN.m | 1 | 0.1 | 0.001 | 0.0001 | 0.0102 | 0.000102 | 0.1418 | 0.00886 | 0.000738 |
| 1cN.m | 10 | 1 | 0.01 | 0.001 | 0.102 | 0.00102 | 1.418 | 0.0886 | 0.00738 |
| 1N.m | 1000 | 100 | 1 | 0.1 | 10.2 | 0.102 | 141.8 | 8.863 | 0.738 |
| 1daN.m | 10000 | 1000 | 10 | 1 | 102 | 1.02 | 1418 | 88.63 | 7.38 |
| 1cm.kg | 98 | 9.8 | 0.098 | 0.0098 | 1 | 0.01 | 13.9 | 0.869 | 0.0724 |
| 1m.kg | 9810 | 981 | 9.81 | 0.98 | 100 | 1 | 1390 | 86.90 | 7.24 |
| 1in.oz | 7.05 | 0.705 | 0.00705 | 0.0007 | 0.072 | 0.0072 | 1 | 0.063 | 0.0052 |
| 1in.lb | 112.8 | 11.28 | 0.1128 | 0.01128 | 1.152 | 0.0115 | 16 | 1 | 0.083 |
| 1ft.lb | 1350 | 135 | 1.35 | 0.135 | 13.8 | 0.138 | 192 | 12 | 1 |



Classic Mechanical Torque Wrenches

- Certified accuracy to $\pm 4\%$

AVT100A



3/8" Classic

| Ref. | Square drive | Torque range Nm | Length mm | List £ |
|---------|--------------|-----------------|-----------|---------|
| AVT100A | 3/8 | 2.5-11 | 318 | £115.44 |
| AVT300A | 3/8 | 5-33 | 422 | £115.44 |
| AVT600 | 3/8 | 12-68 | 476 | £122.48 |

EVT3000A

EVT600A



1/2" Classic

| Ref. | Square drive | Torque range Nm | Length mm | List £ |
|----------|--------------|-----------------|-----------|---------|
| EVT600A | 1/2 | 12-68 | 476 | £122.48 |
| EVT1200A | 1/2 | 25-135 | 546 | £128.85 |
| EVT2000A | 1/2 | 50-225 | 597 | £152.09 |
| EVT3000A | 1/2 | 70-330 | 825 | £179.92 |

- Exceeds the requirements of ISO 6789

HVT5000

GVT8400



3/4" & 1" Classic

| Ref. | Square drive | Torque range Nm | Length mm | List £ |
|---------|--------------|-----------------|-----------|---------|
| HVT5000 | 3/4 | 140-560 | 1130 | £454.34 |
| HVT7200 | 3/4 | 200-810 | 1181 | £454.34 |
| GVT8400 | 1 | 480-940 | 1397 | £662.57 |



Series 2 Torque Wrenches



| TORQUE RANGE | | | | |
|--------------|--------------|-----------------------|-----------|---------|
| Ref. | Drive | Capacity Nm Min. Max. | Length mm | List £ |
| D25T | 1/4" Ratchet | 5 - 25 | 290 | £128.04 |
| A50T | 3/8" Ratchet | 10 - 50 | 370 | £128.04 |
| E100T | 1/2" Ratchet | 20 - 100 | 435 | £128.04 |
| E200T | 1/2" Ratchet | 40 - 200 | 495 | £145.50 |
| E340T | 1/2" Ratchet | 60 - 340 | 650 | £161.80 |

- Strong 72 tooth ratchet
- Split scale adjustment system
 - Linear major scale - for coarse adjustment
 - Rotary minor scale - for fine adjustment
- Positive lock - preventing accidental adjustment whilst in use
- Complies with ISO 6789
- Certified accuracy to $\pm 4\%$

Torque Calibration & Testing



- SI Metric and English imperial units
- Track and peak modes
- Accuracy $\pm 1\%$ over operational range



| Checkmate Torque Testers | | | | |
|--------------------------|---------------|----------|---|----------|
| Ref. | Description | Range Nm | G | List £ |
| CM40 | Torque Tester | 5-50 | R | £1051.46 |
| CM400 | Torque Tester | 36-360 | R | £1051.46 |
| CM1000 | Torque Tester | 110-1100 | R | £1305.97 |

| Torque Multipliers | | | | | | | |
|--------------------|-------|-----------|--------|------------|-----------------------|---|---------|
| Ref. | Input | Max input | Output | Max output | Torque multiplication | G | List £ |
| HXT28 | 3/4 | 560Nm | 1 | 2800Nm | 5 x | R | £736.20 |
| EXT13 | 1/2 | 407Nm | 3/4 | 1350Nm | 3.3 x | R | £696.05 |

Wrenches



Combination Wrenches

Britool combination wrenches feature Stress Relief Drive on the ring end. All open jaw ends feature a constant radius of curvature – reducing stress concentrations and jaw flexing. Both of these features enhance fastener grip and prolong both tool and fastener life. All Britool combination wrenches are manufactured to ISO 7738.

Britool combination wrenches are supplied in four different length variants – short, standard, long and extra long.

Britool combination wrenches are clearly marked with the wrench size on the open jaw head for ease of identification.

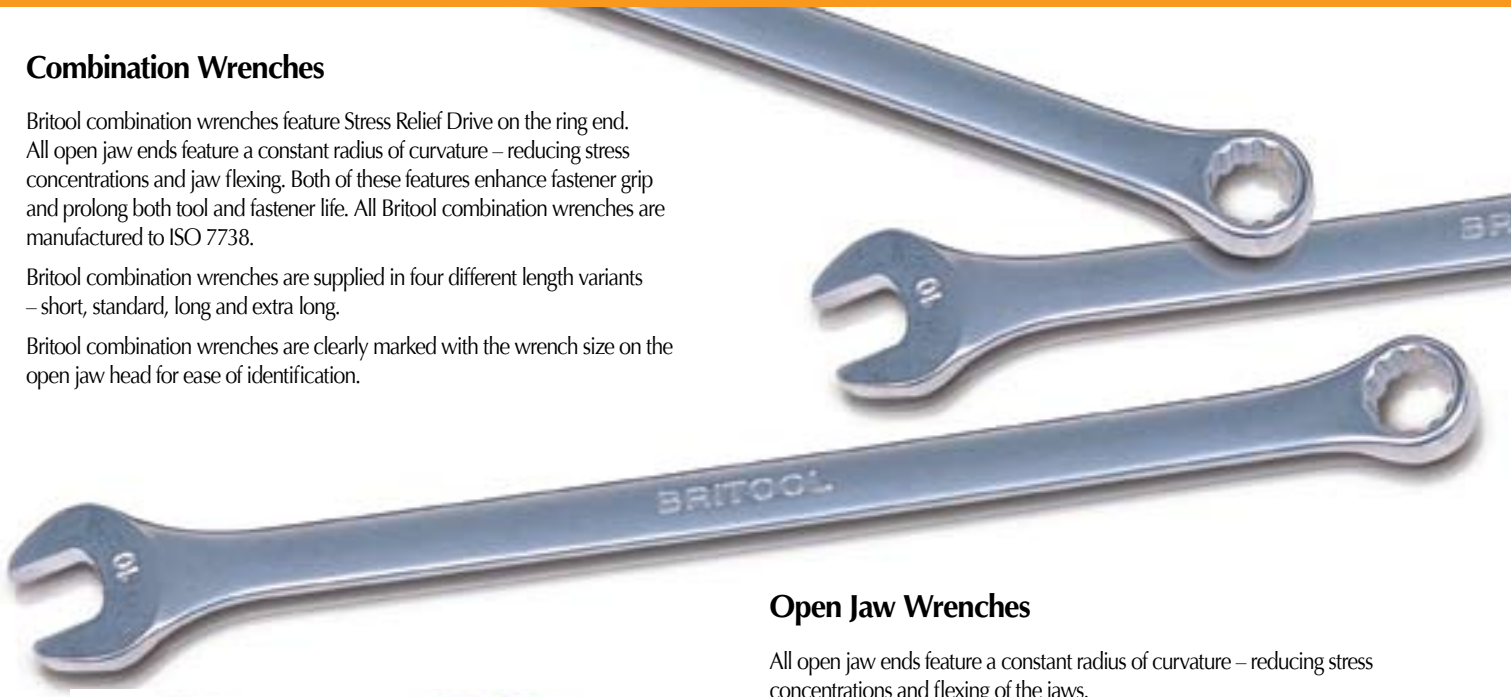

Open Jaw Wrenches

All open jaw ends feature a constant radius of curvature – reducing stress concentrations and flexing of the jaws.

Ring Wrenches

Britool Ring Wrenches are offset at 45° for ease of access and feature Stress Relief Drive.

Britool wrenches are manufactured to the latest ISO standards. All are forged from the highest quality steel and precision machined to exacting standards. They fulfil the needs of the professional engineer.

- Drop forged to ensure uniform grain structure, giving increased strength and reliability
- Heat treated in carefully controlled conditions to ensure optimum performance for every wrench
- Chrome plated for maximum corrosion protection

Britool's advanced Stress Relief Drive (SRD) is standard on all 12 point rings. This reduces fastener wear, assists in the removal of worn fasteners, and enables higher torque loads to be applied.

Britool's advanced ring configuration increases the contact area between the socket and the fastener, minimising stress and reducing the chance of fastener damage.

Because the load is applied to the flat of the fastener, rather than the corners – even if the fastener is already damaged – the drive is superior to a standard profile socket.

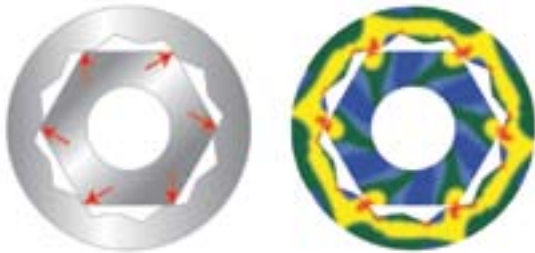

Conventional Profile

Corner point contact gives high stress areas – highlights show contact points on the corner of the fastener

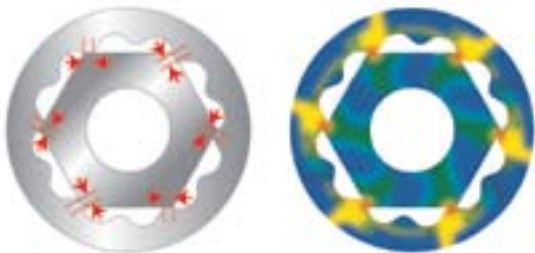

SRD Profile

Distributed surface loads relieves possible stress area – highlights show contact points away from the corner of the fastener

SAFETY MEASURES

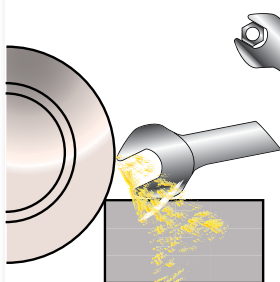

Never grind or alter the shape of the wrench

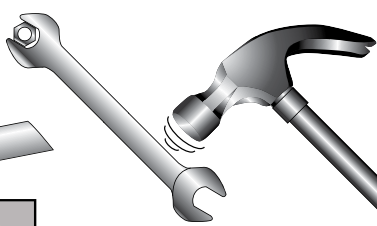

Never hammer or strike a wrench unless it is designed for this purpose



Never work with damaged or chipped tools

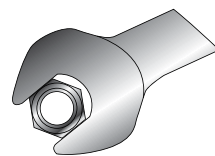

Always ensure there is a positive fit onto the fastener

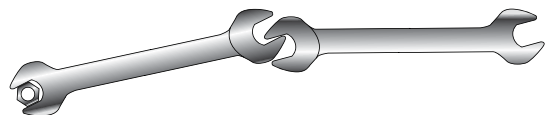

Do not extend length of wrench by locking two together



- 72 tooth mechanism for 5° minimum working arc
- Manufactured from chrome vanadium steel and heat treated for maximum strength
- Precision machined and hardened mechanism
- Flexi head design for ease of access

Flexible Ratcheting Combination Wrench Set

| Ref. | Description | Sizes | List £ |
|------------|-------------------|--|---------|
| RRFJMSET12 | 12 Piece Flexible | 8, 9, 10, 11, 12, 13, 14, 15, 16, 17, 18, 19mm | £153.30 |



- 72 tooth mechanism for 5° minimum working arc
- Manufactured from chrome vanadium steel and heat treated for maximum strength
- Precision machined and hardened mechanism
- Cranked reversible design

Ratcheting Combination Wrench Set

| Ref. | Description | Sizes | List £ |
|----------|-------------|--|---------|
| RRJMSET1 | 12 Piece | 8, 9, 10, 11, 12, 13, 14, 15, 16, 17, 18, 19mm | £124.91 |



- 72 tooth mechanism for 5° minimum working arc
- Manufactured from chrome vanadium steel and heat treated for maximum strength
- Precision machined and hardened mechanism

Double Ended Ratcheting Wrench Set

| Ref. | Description | Sizes | List £ |
|---------|-------------|--|--------|
| RRMSET5 | 5 Piece | 8 x 10, 10 x 11, 12 x 13, 14 x 15, 17 x 19mm | £51.10 |



- Fine tooth mechanism gives a 5° minimum working arc
- Robust mechanism for high torque loads and long working life
- Heat treated chrome-vanadium construction for maximum strength and durability
- Chrome and nickel plating for maximum corrosion protection
- Cranked reversible design

Professional Stubby Combination Wrench Set

| Ref. | Description | Sizes | List £ |
|----------|-------------|------------------------------|--------|
| RRJMSET7 | 7 Piece | 10, 12, 13, 14, 15, 17, 19mm | £55.64 |



- Contains sizes
- Fine tooth mechanism gives a 5° minimum working arc
- Robust mechanism for high torque loads and long working life
- Heat treated chrome-vanadium construction for maximum strength and durability
- Chrome and nickel plating for maximum corrosion protection

4 Piece Professional TX Star Wrench Set

| Ref | Description | Sizes | List £ |
|---------|-------------|--|--------|
| RRTSET4 | 4 Piece | E6 x E8, E10 x E12, E14 x E16, E20 x E24 | £26.32 |



- 72 tooth mechanism for 5° minimum working arc
- Manufactured from chrome vanadium steel and heat treated for maximum strength
- Precision machined and hardened mechanism
- Ratcheting Combination Wrench Set With Rapid Open Jaw Feature

Rapid open jaw design

| Ref. | Description | Sizes | List £ |
|------------|--------------------|--|---------|
| RRJMSET12F | 12 Piece Rapid Jaw | 8, 9, 10, 11, 12, 13, 14, 15, 16, 17, 18, 19 | £103.95 |



- 72 tooth mechanism for 5° minimum working arc
- Manufactured from chrome vanadium steel and heat treated for maximum strength
- Precision machined and hardened mechanism
- Flexi head design for ease of access

Flexi Head Ratcheting Combination Wrenches

| Ref. | Size mm | Length mm | List Price |
|---------|---------|-----------|------------|
| RRFJM8 | 8 | 140 | £11.36 |
| RRFJM9 | 9 | 145 | £11.36 |
| RRFJM10 | 10 | 160 | £11.36 |
| RRFJM11 | 11 | 170 | £11.36 |
| RRFJM12 | 12 | 175 | £11.36 |
| RRFJM13 | 13 | 184 | £12.49 |
| RRFJM14 | 14 | 190 | £12.49 |
| RRFJM15 | 15 | 200 | £13.06 |
| RRFJM16 | 16 | 215 | £13.63 |
| RRFJM17 | 17 | 230 | £14.76 |
| RRFJM18 | 18 | 238 | £15.90 |
| RRFJM19 | 19 | 248 | £15.90 |



- 72 tooth mechanism for 5° minimum working arc
- Manufactured from chrome vanadium steel and heat treated for maximum strength
- Precision machined and hardened mechanism

Reversible Ratcheting Combination Wrenches

| Ref. | Size mm | Length mm | List Price |
|--------|---------|-----------|------------|
| RRJM8 | 8 | 135 | £9.08 |
| RRJM9 | 9 | 140 | £9.08 |
| RRJM10 | 10 | 158 | £9.08 |
| RRJM11 | 11 | 166 | £9.08 |
| RRJM12 | 12 | 170 | £10.22 |
| RRJM13 | 13 | 178 | £10.22 |
| RRJM14 | 14 | 187 | £10.79 |
| RRJM15 | 15 | 198 | £10.79 |
| RRJM16 | 16 | 212 | £12.49 |
| RRJM17 | 17 | 230 | £12.49 |
| RRJM18 | 18 | 238 | £12.49 |
| RRJM19 | 19 | 247 | £13.06 |



- 72 tooth mechanism for 5° minimum working arc
- Manufactured from chrome vanadium steel and heat treated for maximum strength
- Precision machined and hardened mechanism

Stubby Ratcheting Combination Wrenches

| Ref. | Size mm | Length mm | List Price |
|---------|---------|-----------|------------|
| RRJSM10 | 10 | 95 | £6.53 |
| RRJSM12 | 12 | 103 | £7.38 |
| RRJSM13 | 13 | 106 | £7.38 |
| RRJSM14 | 14 | 112 | £7.95 |
| RRJSM15 | 15 | 116 | £7.95 |
| RRJSM17 | 17 | 126 | £10.22 |
| RRJSM19 | 19 | 130 | £10.22 |



- 72 tooth mechanism for 5° minimum working arc
- Manufactured from chrome vanadium steel and heat treated for maximum strength
- Precision machined and hardened mechanism

Double Ended Ratcheting Wrenches

| Ref. | Size mm | Length mm | List Price |
|---------|---------|-----------|------------|
| RRM810 | 8 x 10 | 128 | £10.16 |
| RRM1011 | 10 x 11 | 149 | £10.16 |
| RRM1213 | 12 x 13 | 170 | £11.36 |
| RRM1415 | 14 x 15 | 190 | £12.50 |
| RRM1719 | 17 x 19 | 230 | £13.63 |

Combination Wrenches



- Turns a ratcheting wrench into a low profile – quick release ratchet
- 1/4"SD x 10mm, 3/8"SD x 13mm, 1/2"SD x 19mm

3 Piece Quick Release Adapter Set

| Ref | Description | Sizes | List £ |
|-------|---------------------|---|--------|
| RRSD3 | 3 Piece Adapter Set | 1/4"SD x 10mm, 3/8"SD x 13mm, 1/2"SD x 19mm | £9.03 |



Combination Wrenches - Metric

| Ref. | Size mm | Length mm | List |
|-------|---------|-----------|---------|
| RJM6 | 6 | 109 | £5.53 |
| RJM7 | 7 | 119 | £5.53 |
| RJM8 | 8 | 129 | £5.53 |
| RJM9 | 9 | 139 | £5.53 |
| RJM10 | 10 | 149 | £5.94 |
| RJM11 | 11 | 159 | £5.94 |
| RJM12 | 12 | 169 | £5.94 |
| RJM13 | 13 | 179 | £6.81 |
| RJM14 | 14 | 189 | £6.81 |
| RJM15 | 15 | 199 | £7.74 |
| RJM16 | 16 | 209 | £7.74 |
| RJM17 | 17 | 219 | £8.96 |
| RJM18 | 18 | 229 | £8.96 |
| RJM19 | 19 | 239 | £10.41 |
| RJM20 | 20 | 249 | £11.88 |
| RJM21 | 21 | 259 | £12.51 |
| RJM22 | 22 | 269 | £14.26 |
| RJM23 | 23 | 279 | £15.42 |
| RJM24 | 24 | 289 | £16.13 |
| RJM25 | 25 | 299 | £17.86 |
| RJM26 | 26 | 309 | £20.66 |
| RJM27 | 27 | 319 | £21.12 |
| RJM28 | 28 | 329 | £25.31 |
| RJM30 | 30 | 349 | £27.99 |
| RJM32 | 32 | 269 | £31.60 |
| RJM34 | 34 | 409 | £45.98 |
| RJM36 | 36 | 439 | £48.59 |
| RJM41 | 41 | 479 | £65.13 |
| RJM46 | 46 | 549 | £90.15 |
| RJM50 | 50 | 549 | £110.58 |
| RJM55 | 55 | 609 | £156.49 |
| RJM60 | 60 | 699 | £214.17 |
| RJM65 | 65 | 699 | £259.57 |



Extra Long Combination Wrenches - Metric

| Ref. | Size mm | Length mm | List £ |
|--------|---------|-----------|--------|
| RJXM10 | 10 | 190 | £10.77 |
| RJXM11 | 11 | 208 | £11.00 |
| RJXM12 | 12 | 226 | £11.17 |
| RJXM13 | 13 | 244 | £11.81 |
| RJXM14 | 14 | 262 | £12.22 |
| RJXM15 | 15 | 280 | £12.87 |
| RJXM16 | 16 | 298 | £13.67 |
| RJXM17 | 17 | 315 | £14.90 |
| RJXM18 | 18 | 334 | £15.77 |
| RJXM19 | 19 | 351 | £17.17 |



Combination Wrenches - AF

| Ref. | Size in | Length mm | List |
|--------|---------|-----------|---------|
| RJ250 | 1/4 | 109 | £5.67 |
| RJ312 | 5/16 | 129 | £5.67 |
| RJ344 | 11/32 | 139 | £5.67 |
| RJ375 | 3/8 | 149 | £5.67 |
| RJ437 | 7/16 | 159 | £5.90 |
| RJ500 | 1/2 | 179 | £5.90 |
| RJ562 | 9/16 | 189 | £6.86 |
| RJ625 | 5/8 | 209 | £7.76 |
| RJ687 | 11/16 | 219 | £8.95 |
| RJ750 | 3/4 | 239 | £8.95 |
| RJ812 | 13/16 | 259 | £13.72 |
| RJ875 | 7/8 | 269 | £14.91 |
| RJ937 | 15/16 | 289 | £16.27 |
| RJ1000 | 1 | 299 | £17.90 |
| RJ1062 | 1 1/16 | 319 | £19.58 |
| RJ1125 | 1 1/8 | 339 | £25.86 |
| RJ1250 | 1 1/4 | 369 | £30.67 |
| RJ1312 | 1 5/16 | 409 | £40.49 |
| RJ1375 | 1 3/8 | 409 | £48.22 |
| RJ1437 | 1 7/16 | 439 | £49.48 |
| RJ1500 | 1 1/2 | 439 | £60.64 |
| RJ1625 | 1 5/8 | 479 | £68.36 |
| RJ1687 | 1 11/16 | 479 | £75.37 |
| RJ1750 | 1 3/4 | 549 | £75.37 |
| RJ1812 | 1 13/16 | 549 | £113.49 |
| RJ1875 | 1 7/8 | 549 | £113.49 |



Combination Wrenches - Whitworth

| Ref. | Size in | Whit | BA | Length mm | List £ |
|--------|---------|-------|----|-----------|--------|
| RJ248 | 0.25 | | 4 | 109 | £7.19 |
| RJ324 | 0.32 | | 2 | 129 | £7.20 |
| RJ338 | 0.34 | 1/8 | | 139 | £7.93 |
| RJ413 | 0.41 | | 0 | 159 | £7.20 |
| RJ445 | 0.45 | 3/16 | | 159 | £7.93 |
| RJ525 | 0.53 | 1/4 | | 179 | £8.96 |
| RJ600 | 0.6 | 5/16 | | 209 | £10.48 |
| RJ710 | 0.71 | 3/8 | | 219 | £12.20 |
| RJ820 | 0.82 | 7/16 | | 259 | £15.14 |
| RJ920 | 0.92 | 1/2 | | 289 | £19.45 |
| RJ1010 | 1.01 | 9/16 | | 299 | £25.65 |
| RJ1100 | 1.1 | 5/8 | | 319 | £34.40 |
| RJ1200 | 1.2 | 11/16 | | 369 | £38.12 |
| RJ1300 | 1.3 | 3/4 | | 409 | £51.32 |
| RJ1480 | 1.48 | 7/8 | | 439 | £79.02 |

RJMSET14/TC



RJXMSSET10/TC



RJMSET7L/TC



**Combination Wrench Sets
– In ABS Tool Control Trays**

| Ref. | Description | Sizes | List £ |
|---------------|------------------------------|--|---------|
| RJMSET14/TC | 14 Piece Metric | 6, 7, 8, 9, 10, 11, 12, 13, 14, 15, 16, 17, 18, 19mm | £82.95 |
| RJMSET7L/TC | 7 Piece Metric | 20, 21, 22, 24, 27, 30, 32mm | £89.25 |
| RJXMSSET10/TC | 10 Piece Metric – Extra Long | 10, 11, 12, 13, 14, 15, 16, 17, 18, 19mm | £103.95 |

ND349K



Stubby Combination Wrenches

| Ref. | Description | Sizes | List £ |
|----------|----------------|------------------------------|--------|
| RJMSSET7 | 7 Piece Metric | 10, 12, 13, 14, 15, 17, 19mm | £40.95 |

Combination Wrench Sets

| Ref. | Description | Sizes | List £ |
|----------|--------------------|---|---------|
| RJMSET8 | 8 Piece Metric | 8, 10, 11, 12, 13, 14, 17, 19mm | £46.20 |
| RJMSET11 | 11 Piece Metric | 10, 11, 12, 13, 14, 15, 16, 17, 18, 19, 21mm | £68.25 |
| ND360E | 17 Piece Metric | 7, 8, 9, 10, 11, 12, 13, 14, 15, 16, 17, 18, 19, 21, 22, 23, 24mm | £141.31 |
| RJSET8 | 8 Piece AF | 3/8, 7/16, 1/2, 9/16, 5/8, 11/16, 3/4, 7/8in | £50.40 |
| ND243L | 10 Piece AF | 3/8, 7/16, 1/2, 9/16, 5/8, 11/16, 3/4, 13/16, 7/8, 15/16in | £92.95 |
| ND251D* | 14 Piece AF | 3/8, 7/16, 1/2, 9/16, 5/8, 11/16, 3/4, 13/16, 7/8, 15/16, 1, 1 1/16, 1 1/8, 1 1/4in | £192.64 |
| ND130A | 7 Piece Whitworth | 1/8, 3/16, 1/4, 5/16, 3/8, 7/16, 1/2W | £74.21 |
| ND150J | 11 Piece Whitworth | 1/8, 3/16, 1/4, 5/16, 3/8, 7/16, 1/2, 9/16, 5/8, 11/16, 3/4W | £219.80 |

RJMSET8



RJMSET11



Combination Wrench Sets

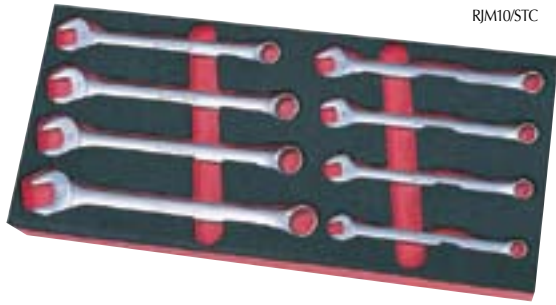

RJM10/STC



RJXMSET10

RJXM7/S

Wrench Sets - Hi-tech Foam

| Ref. | Description | Sizes | List £ |
|-----------|---------------------------|--|--------|
| RJM10/STC | 8 Piece Metric | 10, 11, 12, 13, 14, 16, 17, 19mm | £56.97 |
| RJ10/STC | 8 Piece AF | 1/4, 3/8, 7/16, 1/2, 9/16, 5/8, 11/16, 3/4in | £57.62 |
| RJXM7/STC | 7 Piece Metric Extra Long | 10, 11, 12, 13, 14, 17, 19mm | £89.22 |

Extra Long Combination Wrench Sets

| Ref. | Description | Sizes | List £ |
|-----------|-----------------|--|---------|
| RJXM7/S | 7 Piece Metric | 10, 11, 12, 13, 14, 15, 17mm | £84.79 |
| RJXM7/S19 | 7 Piece Metric | 10, 11, 12, 13, 14, 17, 19mm | £89.22 |
| RJXMSET10 | 10 Piece Metric | 10, 11, 12, 13, 14, 15, 16, 17, 18, 19mm | £103.95 |



Open Jaw Wrenches

Open Jaw Wrenches - Metric

| Ref. | Size mm | Length mm | List £ |
|---------|---------|-----------|--------|
| 2JM67 | 6 x 7 | 121 | £4.71 |
| 2JM78 | 7 x 8 | 138 | £4.71 |
| 2JM89 | 8 x 9 | 140 | £4.71 |
| 2JM1011 | 10 x 11 | 157 | £4.71 |
| 2JM1013 | 10 x 13 | 168 | £5.53 |
| 2JM1213 | 12 x 13 | 171 | £5.53 |
| 2JM1317 | 13 x 17 | 200 | £6.46 |
| 2JM1415 | 14 x 15 | 184 | £6.46 |
| 2JM1617 | 16 x 17 | 200 | £6.46 |
| 2JM1719 | 17 x 19 | 213 | £7.56 |

Open Jaw Wrenches - Metric

| Ref. | Size mm | Length mm | List £ |
|---------|---------|-----------|--------|
| 2JM1819 | 18 x 19 | 213 | £7.56 |
| 2JM1922 | 19 x 22 | 245 | £9.48 |
| 2JM2022 | 20 x 22 | 245 | £10.65 |
| 2JM2123 | 21 x 23 | 245 | £10.65 |
| 2JM2224 | 22 x 24 | 259 | £13.67 |
| 2JM2427 | 24 x 27 | 286 | £19.23 |
| 2JM2430 | 24 x 30 | 313 | £22.23 |
| 2JM2730 | 27 x 30 | 315 | £22.68 |
| 2JM3032 | 30 x 32 | 321 | £23.80 |
| 2JM3236 | 32 x 36 | 368 | £30.38 |
| 2JM3641 | 36 x 41 | 343 | £47.35 |



Open Jaw Wrenches - AF

| Ref. | Size in | Length mm | List £ |
|----------|-----------------|-----------|--------|
| 2J2531 | 1/4 x 5/16 | 121 | £4.30 |
| 2J3137 | 5/16 x 3/8 | 140 | £4.43 |
| 2J3743 | 3/8 x 7/16 | 157 | £4.77 |
| 2J4350 | 7/16 x 1/2 | 171 | £5.53 |
| 2J5056 | 1/2 x 9/16 | 184 | £5.94 |
| 2J5662 | 9/16 x 5/8 | 184 | £6.00 |
| 2J5668 | 9/16 x 11/16 | 200 | £6.35 |
| 2J6268 | 5/8 x 11/16 | 200 | £6.57 |
| 2J6275 | 5/8 x 3/4 | 213 | £7.80 |
| 2J6875 | 11/16 x 3/4 | 213 | £7.80 |
| 2J7587 | 3/4 x 7/8 | 245 | £8.62 |
| 2J8187 | 13/16 x 7/8 | 245 | £9.25 |
| 2J8193 | 13/16 x 15/16 | 245 | £9.61 |
| 2J93100 | 15/16 x 1 | 259 | £13.91 |
| 2J93112 | 15/16 x 1 1/8 | 285 | £18.74 |
| 2J106112 | 1 1/16 x 1 1/8 | 315 | £19.50 |
| 2J106125 | 1 1/16 x 1 1/4 | 317 | £20.84 |
| 2J125143 | 1 1/4 x 1 7/16 | 330 | £31.77 |
| 2J131150 | 1 5/16 x 1 1/2 | 330 | £33.93 |
| 2J162181 | 1 5/8 x 1 13/16 | 432 | £50.99 |
| 2J168187 | 1 11/16 x 1 7/8 | 432 | £52.67 |



Open Jaw Wrenches - Whitworth

| Ref. | Size in | Whit | Length mm | List £ |
|----------|-------------|---------------|-----------|--------|
| 2J3344 | 0.34 x 0.45 | 1/8 x 3/16 | 157 | £6.63 |
| 2J4452 | 0.45 x 0.53 | 3/16 x 1/4 | 171 | £7.30 |
| 2J5260 | 0.53 x 0.60 | 1/4 x 5/16 | 184 | £7.86 |
| 2J6071 | 0.60 x 0.71 | 5/16 x 3/8 | 200 | £9.33 |
| 2J7182 | 0.71 x 0.82 | 3/8 x 7/16 | 213 | £11.57 |
| 2J8292 | 0.82 x 0.92 | 7/16 x 1/2 | 245 | £13.77 |
| 2J92101 | 0.92 x 1.01 | 1/2 x 9/16 | 259 | £17.15 |
| 2J101110 | 1.01 x 1.10 | 1/2 x 5/8 | 283 | £22.48 |
| 2J101120 | 1.01 x 1.20 | 9/16 x 11/16 | 322 | £27.83 |
| 2J110120 | 1.10 x 1.20 | 5/8 x 11/16 | 317 | £28.83 |
| 2J120130 | 1.20 x 1.30 | 11/16 x 3/4 | 321 | £33.44 |
| 2J130148 | 1.30 x 1.48 | 3/4 x 7/8 | 330 | £49.90 |
| 2J148167 | 1.48 x 1.67 | 7/8 x 1 | 384 | £69.74 |
| 2J186205 | 1.86 x 2.05 | 1 1/8 x 1 1/4 | 467 | £81.90 |



Midget Open Jaw Wrenches - BA

| Ref. | Size in | BA | Length mm | List £ |
|--------|-------------|--------|-----------|--------|
| 5J1013 | 0.10 x 0.13 | 11 x 9 | 70 | £4.59 |
| 5J1115 | 0.12 x 0.15 | 10 x 8 | 70 | £4.62 |
| 5J1722 | 0.17 x 0.22 | 7 x 5 | 80 | £4.62 |
| 5J1924 | 0.19 x 0.25 | 6 x 4 | 80 | £4.62 |
| 5J2432 | 0.25 x 0.32 | 4 x 2 | 80 | £4.62 |
| 5J2836 | 0.28 x 0.37 | 3 x 1 | 90 | £5.08 |
| 5J3241 | 0.32 x 0.41 | 2 x 0 | 100 | £5.13 |

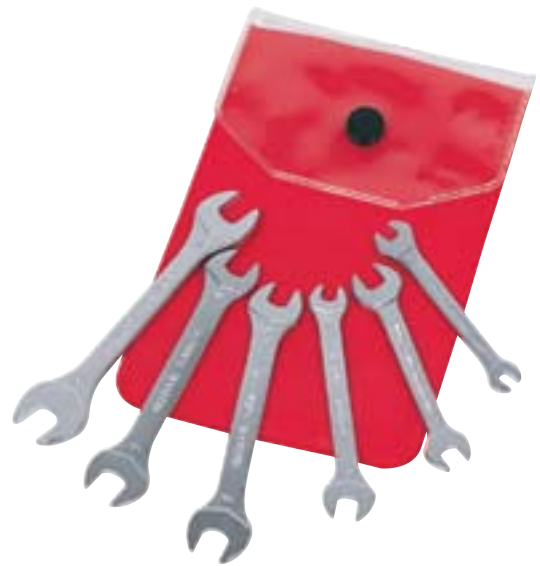

*Supplied in red PVC wallet

Midget Open Jaw Wrench Sets

| Ref. | Description | Sizes | List £ |
|--------|-------------|--|--------|
| NB108T | 6 Piece BA | 11 x 9, 10 x 8, 7 x 5, 6 x 4, 3 x 1, 2 x 0BA | £24.45 |

Open Jaw Wrench Sets

| Ref. | Description | Sizes | List £ |
|---------|-------------------|--|---------|
| S2JM10 | 10 piece Metric | 6 x 7, 7 x 8, 8 x 9, 10 x 13, 10 x 11, 12 x 13, 14 x 15, 16 x 17, 17 x 19, 18 x 19mm | £42.66 |
| NB351G | 11 piece Metric | 6 x 7, 8 x 9, 10 x 11, 12 x 13, 14 x 15, 16 x 17, 18 x 19, 20 x 22, 21 x 23, 24 x 26 & 27 x 30mm | £91.20 |
| NB227D* | 6 piece AF | 5/16 x 3/8, 7/16 x 1/2, 9/16 x 5/8, 11/16 x 3/4, 13/16 x 7/8, 15/16 x 1in | £44.70 |
| NB231E | 7 piece AF | 5/16 x 3/8, 3/8 x 7/16, 7/16 x 1/2, 1/2 x 9/16, 9/16 x 5/8, 5/8 x 11/16, 11/16 x 3/4in | £40.10 |
| NB250P | 10 piece AF | 1/4 x 5/16, 5/16 x 3/8, 3/8 x 7/16, 7/16 x 1/2, 1/2 x 9/16, 9/16 x 5/8, 5/8 x 11/16, 11/16 x 3/4, 3/4 x 7/8, 15/16 x 1in | £65.01 |
| NB131R | 7 piece Whitworth | 1/8 x 3/16, 3/16 x 1/4, 1/4 x 5/16, 5/16 x 3/8, 3/8 x 7/16, 7/16 x 1/2, 1/2 x 9/16W | £69.71 |
| NB141C | 9 piece Whitworth | 1/8 x 3/16, 3/16 x 1/4, 1/4 x 5/16, 5/16 x 3/8, 3/8 x 7/16, 7/16 x 1/2, 1/2 x 9/16, 9/16 x 5/8, 5/8 x 11/16W | £119.71 |



Open Jaw Wrench Sets in ABS Tool Control Trays

| Ref. | Description | Sizes | List £ |
|------------|----------------|--|--------|
| 2JMSET8/TC | 8 Piece Metric | 6, 7, 8, 9, 10, 11, 12, 13, 14, 15, 16, 17, 18, 19mm | £37.80 |

Ring Wrenches



Ring Wrenches - Metric

| Ref. | Size mm | Length mm | List £ |
|----------|---------|-----------|--------|
| 9RBM67 | 6 x 7 | 168 | £6.27 |
| 9RBM89 | 8 x 9 | 183 | £6.65 |
| 9RBM1011 | 10 x 11 | 198 | £7.18 |
| 9RBM1213 | 12 x 13 | 217 | £7.57 |
| 9RBM1415 | 14 x 15 | 239 | £8.01 |
| 9RBM1617 | 16 x 17 | 260 | £8.69 |
| 9RBM1819 | 18 x 19 | 292 | £10.06 |



Ring Wrench Sets - Hi-tech Foam

| Ref. | Description | Sizes | List £ |
|-----------|----------------|---|--------|
| NC391T/TC | 7 Piece Metric | 6 x 7, 8 x 9, 10 x 11, 12 x 13, 14 x 15, 16 x 17, 18 x 19mm | £65.18 |

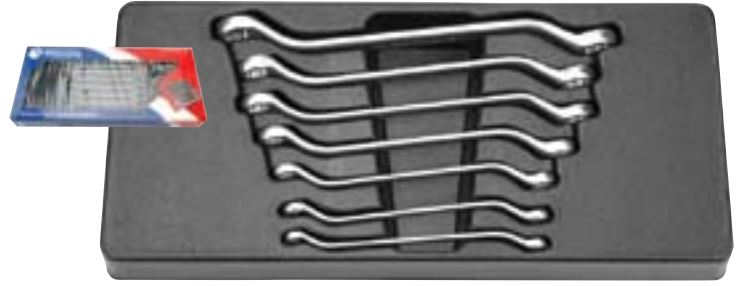

Ring Wrench Sets in ABS Tool Control Trays

| Ref. | Description | Sizes | List £ |
|-------------|----------------|---|--------|
| RRBMSET7/TC | 7 Piece Metric | 6x7, 8x9, 10x11, 12x13, 14x15, 16x17, 18x19mm | £47.25 |

Ring Wrench Sets

| Ref. | Description | Sizes | List £ |
|--------|----------------|---|--------|
| NC381T | 7 Piece Metric | 6 x 7, 8 x 9, 10 x 11, 12 x 13, 14 x 15, 16 x 17, 18 x 19mm | £53.25 |



Extra Long Ring Wrench Set

| Ref. | Description | Sizes | List £ |
|----------|----------------|---------------------|--------|
| RRLMSET3 | 3 Piece Metric | 10x12, 13x14, 17x19 | £51.45 |

Ratcheting Ring Wrenches



Offset Ratcheting Wrenches - Metric

| Ref. | Size mm | Length mm | List £ |
|----------|---------|-----------|--------|
| RBOM78 | 7 x 8 | 109 | £11.92 |
| RBOM910 | 9 x 10 | 138 | £13.77 |
| RBOM1112 | 11 x 12 | 168 | £17.49 |
| RBOM1314 | 13 x 14 | 168 | £17.49 |
| RBOM1517 | 15 x 17 | 200 | £20.47 |
| RBOM1921 | 19 x 21 | 227 | £22.54 |

Offset Ratcheting Wrenches - AF

| Ref. | Size in | Length mm | List £ |
|---------|-------------|-----------|--------|
| RBO2531 | 1/4 x 5/16 | 109 | £11.15 |
| RBO3743 | 3/8 x 7/16 | 138 | £12.65 |
| RBO5056 | 1/2 x 9/16 | 168 | £18.93 |
| RBO6268 | 5/8 x 11/16 | 168 | £21.14 |
| RBO7587 | 3/4 x 7/8 | 227 | £21.63 |



Flat Ratcheting Wrenches - Metric

| Ref. | Size mm | Length mm | List £ |
|---------|---------|-----------|--------|
| RBB78 | 7 x 8 | 108 | £10.88 |
| RBB910 | 9 x 10 | 140 | £12.22 |
| RBB1112 | 11 x 12 | 171 | £15.49 |
| RBB1314 | 13 x 14 | 171 | £15.49 |
| RBB1517 | 15 x 17 | 203 | £18.57 |
| RBB1618 | 16 x 18 | 203 | £18.57 |
| RBB1921 | 19 x 21 | 235 | £20.59 |

Flat Ratcheting Wrenches - AF

| Ref. | Size in | Length mm | List £ |
|---------|-------------|-----------|--------|
| RBB2531 | 1/4 x 5/16 | 108 | £9.94 |
| RBB3743 | 3/8 x 7/16 | 140 | £11.72 |
| RBB4350 | 7/16 x 1/2 | 171 | £17.76 |
| RBB5056 | 1/2 x 9/16 | 171 | £17.20 |
| RBB5662 | 9/16 x 5/8 | 203 | £19.76 |
| RBB6268 | 5/8 x 11/16 | 203 | £19.58 |
| RBB7587 | 3/4 x 7/8 | 235 | £19.92 |



Ratcheting Box Wrench Set

| Ref. | Description | Sizes | List £ |
|------------|-----------------------------------|---|--------|
| RCHWRENCH1 | 6 Piece Ratcheting Box Wrench Set | 7 x 8, 9 x 10, 11 x 12, 13 x 14, 15 x 17, 19 x 21mm | £81.76 |



Ratcheting Ring Wrench Sets

| Ref. | Description | Sizes | List £ |
|--------|----------------------------------|--|--------|
| RBMSET | 5 Piece Metric Ratcheting Offset | 7 x 8, 9 x 10, 11 x 12, 15 x 17, 19 x 21mm | £77.24 |
| RBOSET | 5 Piece AF Ratcheting Offset | 1/4 x 5/16, 3/8 x 7/16, 1/2 x 9/16, 5/8 x 11/16, 3/4 x 7/8in | £75.37 |

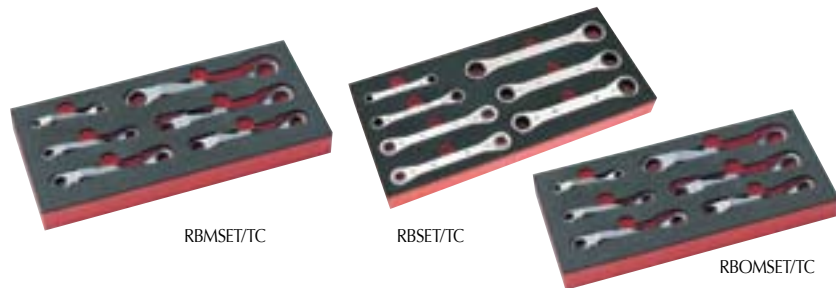

Ratcheting Box Wrench Set

| Ref. | Description | Sizes | List £ |
|---------|--|--|--------|
| RRMSET5 | 5 Piece Double Ended Ratcheting Wrench Set | 8 x 10, 10 x 11, 12 x 13, 14 x 15, 17 x 19 | £51.10 |

Ratcheting Ring Wrench Sets - Hi-tech Foam

| Ref. | Description | Sizes | List £ |
|------------|--|--|---------|
| RBMSET/TC | 7 Piece Metric Ratcheting Ring Wrench Set | 7 x 8, 9 x 10, 11 x 12, 13 x 14, 15 x 17, 16 x 18, 19 x 21mm | £108.19 |
| RBSET/TC | 7 Piece AF Ratcheting Ring Wrench Set | 1/4 x 5/16, 3/8 x 7/16, 7/16 x 1/2, 1/2 x 9/16, 9/16 x 5/8, 5/8 x 11/16, 3/4 x 7/8in | £113.49 |
| RBOMSET/TC | 6 Piece Metric Ratcheting Offset Ring Wrench Set | 7 x 8, 9 x 10, 11 x 12, 13 x 14, 15 x 17, 19 x 21mm | £99.93 |

Miscellaneous Wrenches



'C' Hook Wrenches

| Ref. | Size mm | Length mm | List £ |
|------|---------|-----------|--------|
| 3150 | 19-51 | 165 | £18.42 |
| 3151 | 32-76 | 216 | £25.44 |
| 3152 | 51-121 | 267 | £33.50 |



Adjustable Wrenches - Chrome

| Ref. | Jaw Opening (max) mm | Length mm | List £ |
|------|----------------------|-----------|---------|
| 306C | 19 | 152 | £19.20 |
| 308C | 26 | 203 | £22.40 |
| 310C | 30 | 254 | £27.41 |
| 312C | 34 | 305 | £36.82 |
| 315C | 42 | 381 | £59.78 |
| 318C | 53 | 457 | £105.14 |



- Monoblock cast iron handle with I beam construction for strength and rigidity under load
- Handle and moving jaw are forged from high quality steel – heat treated to ensure maximum strength and wear resistance

Heavy Duty Pipe Wrenches

| Ref | Length mm | Max Jaw Capacity mm | List £ |
|-------|-----------|---------------------|--------|
| PW200 | 200 | 34 | £20.51 |
| PW250 | 250 | 49 | £23.94 |
| PW300 | 300 | 60 | £27.65 |
| PW350 | 350 | 60 | £31.70 |
| PW450 | 450 | 76 | £45.37 |



- Designed for scaffolding and steel work applications
- Heavy duty 32 tooth ratchet mechanism
- Zinc plated
- Stress relief drive on all socket heads
- Double sided mechanism gives two sizes per wrench

Ratcheting Podger Wrenches

| Ref. | Description | List £ |
|----------|-------------|--------|
| RRPM1719 | 17 x 19 | £19.30 |
| RRPM1921 | 19 x 21 | £21.58 |
| RRPM2427 | 24 x 27 | £26.12 |

Screwdrivers & Insert Bits



Screwdrivers Technical Information

The performance of Britool screwdrivers exceeds ISO standards. This comprehensive range gives outstanding performance, providing optimum torque with a minimum of user fatigue.

Range

Britool screwdrivers are available with a full range of tips including long reach versions.

Screwdriver Blades

All Britool screwdriver blades have shot blasted tips to give increased grip—ensuring positive fastener location, and reducing slippage and possible damage or injury.

Heat treatment gives the correct balance of hardening and tempering—for optimum hardness without being brittle.

Blades designed to fit large fasteners incorporate a hexagon bolster, allowing a wrench to be used if extra torque is required.

Screwdriver Handles

Britool screwdriver handles are ergonomically designed with a two piece construction combining comfort in use with durability. A soft, textured rubber grip allows maximum torque to be applied without discomfort.

The tough bi-material handle is moulded directly onto the flanged blade, preventing the blade from twisting or pulling out of the handle.

- Colour coded for easy identification
- Textured finish ensures a firm grip even when greasy
- Large diameter handle gives a positive grip when applying high torque loads
- Small diameter area aids accurate location and fast screw turning
- Holed handle allows easy and safe storage

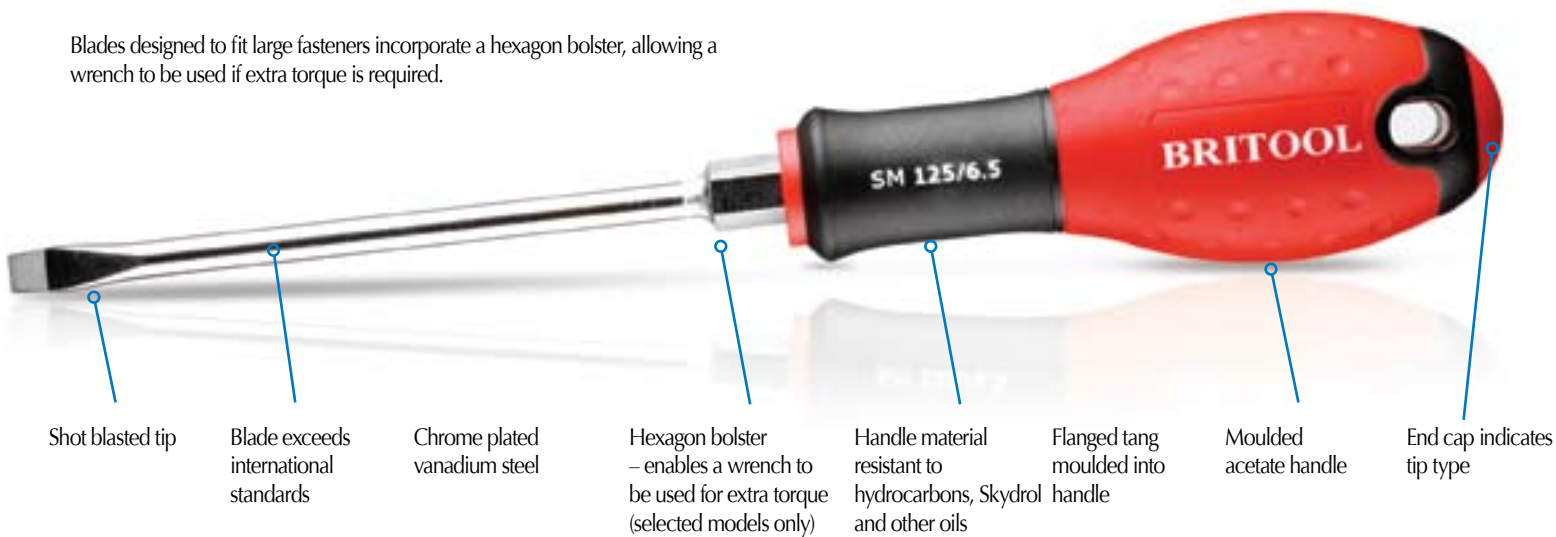

Engineers Screwdrivers



Flared Tip

| Ref. | Length mm | Tip width mm | List £ |
|-----------|-----------|--------------|--------|
| SM100/5.5 | 100 | 5.5 | £4.60 |
| SM125/6.5 | 125 | 6.5 | £6.22 |
| SM150/6.5 | 150 | 6.5 | £6.35 |
| SM150/8 | 150 | 8.0 | £8.27 |
| SM250/8 | 250 | 8.0 | £8.73 |
| SM200/10 | 200 | 10.0 | £10.59 |
| SM250/12 | 250 | 12.0 | £12.22 |

Torx

| Ref. | Length mm | Tip | List £ |
|----------|-----------|-----|--------|
| SM75T10 | 75 | T10 | £4.70 |
| SM75T15 | 75 | T15 | £5.38 |
| SM100T20 | 100 | T20 | £6.42 |
| SM100T25 | 100 | T25 | £7.63 |
| SM100T27 | 100 | T27 | £7.63 |
| SM125T30 | 125 | T30 | £7.88 |
| SM125T40 | 125 | T40 | £9.65 |

Tamper Proof Torx

| Ref. | Length mm | Tip | List £ |
|------------|-----------|-----|--------|
| SM75TPT10 | 75 | T10 | £4.77 |
| SM75TPT15 | 75 | T15 | £5.45 |
| SM100TPT20 | 100 | T20 | £6.47 |
| SM100TPT25 | 100 | T25 | £7.72 |
| SM100TPT27 | 100 | T27 | £7.95 |
| SM125TPT30 | 125 | T30 | £7.95 |
| SM125TPT40 | 125 | T40 | £9.65 |



Pozidriv

| Ref. | Length mm | Tip | List £ |
|----------|-----------|-----|--------|
| SM75PZ0 | 75 | PZ0 | £4.19 |
| SM75PZ1 | 75 | PZ1 | £4.77 |
| SM100PZ1 | 100 | PZ1 | £5.29 |
| SM125PZ2 | 125 | PZ2 | £7.34 |
| SM150PZ3 | 150 | PZ3 | £9.66 |
| SM200PZ4 | 200 | PZ4 | £12.22 |



Stubby Pozidriv

| Ref. | Length mm | Tip | List £ |
|---------|-----------|-----|--------|
| SM30PZ1 | 30 | PZ1 | £4.89 |
| SM30PZ2 | 30 | PZ2 | £5.06 |

Electricians Screwdrivers



Parallel Tip

| Ref. | Length mm | Tip width mm | List £ |
|-----------|-----------|--------------|--------|
| SE50/2.5 | 50 | 2.5 | £2.27 |
| SE50/3 | 50 | 3.0 | £2.44 |
| SE75/3.5 | 75 | 3.5 | £2.62 |
| SE100/3.5 | 100 | 3.5 | £3.20 |
| SE100/4 | 100 | 4.0 | £3.20 |
| SE150/4 | 150 | 4.0 | £3.96 |
| SE150/5.5 | 150 | 5.5 | £4.25 |
| SE175/6.5 | 175 | 6.5 | £4.95 |
| SE250/5 | 250 | 5.0 | £4.60 |



Phillips

| Ref. | Length mm | Tip | List £ |
|----------|-----------|------|--------|
| SE50PH00 | 50 | PH00 | £2.50 |
| SE75PH0 | 75 | PH0 | £2.79 |
| SE75PH1 | 75 | PH1 | £3.69 |
| SE100PH1 | 100 | PH1 | £4.19 |
| SE125PH2 | 125 | PH2 | £6.22 |
| SE150PH3 | 150 | PH3 | £8.55 |
| SE200PH4 | 200 | PH4 | £11.23 |

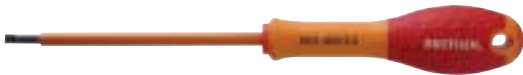

Insulated Parallel Tip

| Ref. | Length mm | Tip width mm | List £ |
|------------|-----------|--------------|--------|
| SES50/2.5 | 50 | 2.5 | £3.43 |
| SES100/3.5 | 100 | 3.5 | £3.90 |
| SES150/4 | 150 | 4.0 | £5.18 |
| SES175/5.5 | 175 | 5.5 | £6.81 |



Insulated Phillips

| Ref. | Length mm | Tip | List £ |
|----------|-----------|------|--------|
| SE50PH00 | 50 | PH00 | £3.55 |
| SE75PH0 | 75 | PH0 | £4.08 |
| SE100PH1 | 100 | PH1 | £6.05 |
| SE125PH2 | 125 | PH2 | £8.55 |



Stubby Parallel Tip

| Ref. | Length mm | Tip width mm | List £ |
|----------|-----------|--------------|--------|
| SE30/4 | 30 | 4.0 | £3.67 |
| SE30/5.5 | 30 | 5.5 | £3.72 |
| SE30/6.5 | 30 | 6.5 | £3.84 |



Stubby Phillips

| Ref. | Length mm | Tip | List £ |
|---------|-----------|-----|--------|
| SE30PH1 | 30 | PH1 | £4.19 |
| SE30PH2 | 30 | PH2 | £4.30 |





| Screwdriver Sets | | | |
|------------------|---|---|--------|
| Ref. | Description | Sizes | List £ |
| SDS5 | 5 Piece Flared & Parallel Tip | Flared Tip: 6.5, 8mm Parallel Tip: 3.5, 4, 5.5mm | £26.19 |
| SDS6 | 6 Piece Pozidriv, Flared & Parallel Tip | Flared Tip: 5.5, 6.5, 8mm Parallel Tip: 3.5mm Pozidriv: PZ1, PZ2 | £31.80 |
| SDS7 | 7 Piece Pozidriv, Flared & Parallel Tip | Flared Tip: 5.5, 6.5, 8mm Parallel Tip: 3.5, 4mm Pozidriv: PZ1, PZ2 | £34.07 |

| Micro Screwdriver Sets | | | |
|------------------------|---------------------------------------|--|--------|
| Ref. | Description | Sizes | List £ |
| SL4/S | 4 Piece Torx Micro Set | T6, 7, 8, 9 | £19.25 |
| SL6/S | 6 Piece Slotted / Phillips Micro set | Slotted: 2, 2.5, 3 Phillips: PH000, 00, 0 | £14.91 |
| SL8/S | 9 Piece Interchangeable Tip Micro Set | Slotted: 1, 1.2, 1.5, 1.8, 2, 2.5mm Phillips: PH000, PH00 | £15.46 |

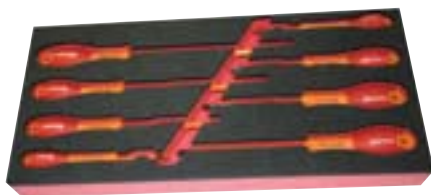

SDS8/TC



SDRIV1



SDRIV3



SDS9/TC



SDRIV4



SDRIV2



SDS11



SDRIV6



SDS7/2TC

| Screwdriver Sets - Hi-tech Foam | | | |
|---------------------------------|--|---|--------|
| Ref. | Description | Sizes | List £ |
| SDS7/2TC | 7 Piece Torx Set | Torx: T10, 15, 20, 25, 27, 30, 40 | £46.50 |
| SDS8/TC | 8 Piece Insulated Screwdriver Set | Insulated Parallel Tip: 2.5, 3.5, 4, 5.5mm Insulated Phillips Tip: PH00, PH0, PH1, PH2 | £37.67 |
| SDS9/TC | 9 Piece Phillips, Flared & Parallel Tip | Flared Tip: 6.5, 8. Parallel Tip: 3.5, 4, 5.5 4mm Stubby, Phillips: PH1, PH2 PH1 Stubby | £41.85 |
| SDS11 | 11 Piece Pozidriv, Flared & Parallel Tip | Flared Tip: 5.5, 6.5, 8. Parallel Tip: 3.5, 4, 6.5mm Stubby, Pozidriv: PZ0, PZ1, PZ2, PH3, PZ2 Stubby | £59.95 |

| Screwdriver Sets | | | |
|------------------|---|--|--------|
| Ref. | Description | Sizes | List £ |
| SDRIV1 | 8 Piece Flared & Pozidriv Set Tip | Flared Tip :3.5, 4, 5.5, 6.5, 8 Pozidriv PZ0, PZ1, PZ2 | £36.34 |
| SDRIV2 | 7 Piece Torx Screwdriver Set | Torx T10, T15, T20, T25, T27, T30, T40 | £42.58 |
| SDRIV3 | 8 Piece Insulated Screwdriver Set | Insulated Parallel Tip : 2.5, 3.5, 4, 5.5 Phillips PH00, PH0, PH1, PH2 | £36.34 |
| SDRIV4 | 8 Piece Flared & Phillips Screwdriver Set Insulated | Flared Tip :3.5, 4, 5.5, 6.5, 8 Pozidriv PH0, PH1, PH2 | £34.07 |
| SDRIV5 | 7 Piece Tamper Proof Torx Screwdriver Set | Tamper Proof Torx:T10, T15, T20, T25, T27, T30, T40 | £42.58 |
| SDRIV6 | 7 Piece Stubby Screwdriver Set | Slotted Tip: 4, 5.5, 6.5 Philips PH1, PH2 Pozidriv PZ1, 2 | £29.63 |

Ratcheting Screwdrivers



- Robust gearless mechanism – gives less than 1° minimum working arc
- Negligible reverse torque
- Magnetic bit retention
- Complete with bits: Pozidriv 1, 2, Phillips 1, 2 Slotted 4 & 6.5mm

Gearless Ratcheting Screwdrivers

| Ref. | Description | Insert Bits | Length mm | List £ |
|-------|--|--|-----------|--------|
| BCSD1 | Gearless ratcheting screwdriver | Phillips® PH1, 2 Pozidriv® PZ1, 2 Slotted 4, 6.5mm | 225 | £9.03 |
| BCSD2 | Stubby gearless ratcheting screwdriver | Phillips® PH1, 2 Pozidriv® PZ1, 2 Slotted 4, 6.5mm | 115 | £7.89 |
| BCSD3 | Long reach gearless ratcheting screwdriver | Phillips® PH1, 2 Pozidriv® PZ1, 2 Slotted 4, 6.5mm | 310 | £10.79 |



Professional 35 Piece Ratcheting Screwdriver Set

| Ref | Contents | List £ |
|----------|---|--------|
| BRSDSET1 | <ul style="list-style-type: none"> • Fine tooth ratcheting screwdriver handle • 1/4" hexagon screwdriver blades - 150mm, 250mm • 1/4" square drive screwdriver blade - 250mm • 1/4" flexible screwdriver blade - 290mm • Hexagon bits: 3,4,5,6,7 & 8mm • Slotted bits: 4,5,5 & 7mm • Pozidriv® bits: #1,2 & 3 • Phillips® bits: #1,2 & 3 • Torx® bits: TX10,15,20,25,27,30 & 40 • Tamperproof Torx® bits: TTX10,15,20,25,27,30 & 40 • 1/4" hex - 1/4" square drive adaptor | £51.10 |



- Handle can be adjusted to give an ergonomic pistol grip design allowing much higher torque loads to be applied
- Adjustable grip ratcheting screwdriver with 1/4" hexagon drive and interchangeable blade
- Cartridge style 6 bit holder
- Fine tooth high load reversible ratchet mechanism

Adjustable Grip Ratcheting Screwdriver

| Ref | Insert Bits | List £ |
|--------|---|--------|
| BRSDF1 | Phillips® Tip: Ph1, 2, Pozidriv® Tip: Pz1, 2 Slotted: 4, 6.5mm | £25.55 |



- Fine tooth, high load reversible mechanism
- Soft touch ergonomic handle
- Soft eject, integral bit holder
- Complete with six S2 alloy steel bits

Professional Ratcheting Screwdriver

| Ref | Insert Bits | List £ |
|-------|---|--------|
| BRSD2 | Phillips® Tip: Ph1, 2, Pozidriv® Tip: Pz1, 2 Slotted: 4, 6.5mm | £20.44 |



18 Piece Stubby Ratcheting Screwdriver Set

| Ref | Contents | List £ |
|----------|---|--------|
| BRSDSET2 | <ul style="list-style-type: none"> • Fine tooth stubby ratcheting screwdriver handle • 50mm 1/4" hexagon drive screwdriver blade • 150mm 1/4" square drive flexible screwdriver blade • 5 1/4" square drive sockets 4, 4.5, 5, 5.5, 6mm • 1/4" Hexagon (female) / 1/4" square drive adapter (female) • 9 1/4" square drive S2 steel insert bits • 2 Slotted bits: 4, 6.5mm • 3 Pozidriv bits; Pz1, 2, 3 • 3 Phillips bits; Ph1, 2, 3 • 1/4" Hexagon (male) / 1/4" square drive adapter (male) | £23.85 |



31 Piece Multi-Pattern Bit Set

| Ref | Contents | List £ |
|-------|--|--------|
| BBS31 | <ul style="list-style-type: none"> Locking bit holder • Slotted bits: 3.5,4.5,5.5,6.5 & 8mm Phillips® bits: Ph1,2(x2) & 3 • Pozidriv® bits: Pz1,2(x2) & 3 Hexagon bits: 2,3,4,5,6,7 & 8mm • Tamperproof Torx® bits: 9,10,15,20,25,27,30 & 40mm • Robertson® square bits: #1 & 2 | £14.19 |

Hexagon Insert Bits

| Ref. | Size AF | Hex Drive | Length mm | List £ |
|---------|---------|-----------|-----------|--------|
| 1USB093 | 3/32" | 1/4" | 25 | £4.04 |
| 1USB125 | 1/8" | 1/4" | 25 | £4.04 |
| 1USB156 | 5/32" | 1/4" | 25 | £4.04 |
| 1USB187 | 3/16" | 1/4" | 25 | £4.04 |
| 1USB250 | 1/4" | 1/4" | 25 | £4.04 |
| 1USB2M | 2 mm | 1/4" | 25 | £2.99 |
| 1USB25M | 2.5 mm | 1/4" | 25 | £2.99 |
| 1USB3M | 3 mm | 1/4" | 25 | £4.04 |
| 1USB4M | 4 mm | 1/4" | 25 | £3.97 |
| 1USB5M | 5 mm | 1/4" | 25 | £4.21 |
| 1USB6M | 6 mm | 1/4" | 25 | £4.21 |
| 2USB187 | 3/16" | 5/16" | 30 | £4.39 |
| 2USB218 | 7/16" | 5/16" | 30 | £4.39 |
| 2USB250 | 1/4" | 5/16" | 30 | £4.89 |
| 2USB312 | 5/16" | 5/16" | 30 | £4.89 |
| 2USB5M | 5 mm | 5/16" | 30 | £5.01 |
| 2USB6M | 6 mm | 5/16" | 30 | £5.01 |
| 2USB8M | 8 mm | 5/16" | 30 | £5.80 |
| 3USB375 | 3/8" | 14 mm | 40 | £7.27 |
| 3USB500 | 1/2" | 14 mm | 40 | £7.27 |
| 3USB562 | 9/16" | 14 mm | 40 | £7.27 |
| 3USB10M | 10 mm | 14 mm | 40 | £7.27 |
| 3USB12M | 12 mm | 14 mm | 40 | £7.27 |
| 3USB14M | 14 mm | 14 mm | 40 | £7.27 |

Long Reach Slotted Screw Insert Bits

| Ref. | Point Width | Point Thickness | Hex Drive | List £ |
|-------|-------------|-----------------|-----------|--------|
| 2USS5 | 5.5 | 0.87 | 5/16" | £4.89 |
| 2USS6 | 6.0 | 1.07 | 5/16" | £5.19 |
| 2USS7 | 7.0 | 1.24 | 5/16" | £5.19 |

Bit Holders

| Ref. | [F] Hex AF | [M] Hex AF | Length mm | List £ |
|-------|------------|------------|-----------|--------|
| D1UBA | 1/4" | 1/4" | 22 | £6.93 |
| A1UBA | 3/8" | 1/4" | 28 | £7.45 |

109 Piece Multi-Pattern Bit Set & Driver

| Ref | Contents | List £ |
|--------|--|--------|
| BBS109 | <ul style="list-style-type: none"> Multi-bit, quick release bit driver • Flexible extension • Drill bit adaptor • 1/2" hex - 1/4" female square adaptor • 1/4" hex - 1/4" male adaptor • Hook adaptor • Phillips® bits: Ph0-4 + 4 spares Pozidriv® bits: Pz0-4 + 4 spares • Slotted bits • Robertson® square bits: #0-4 • Electrical security bits: #1-3 • Torx® bits: TX5 - TX50 Tamperproof Torx® bits: TX6 - 40 • Hex bits: 1.5-8mm • Security hex bits: 1.5-8mm & 5/64 - 5/32" • Spline bits: SP4 - 8 • Torq-Set bits: #1/4 - 4 • Tri-wing bits: TW1 - 5 • Snake eye bits: 4-12 | £51.10 |

Slotted Insert Bits

| Ref. | Point Width | Point Thickness | Hex Drive | List £ |
|---------|-------------|-----------------|-----------|--------|
| 1USS4T | 4 | 0.57 | 1/4" | £1.95 |
| 1USS45T | 4.5 | 0.65 | 1/4" | £1.95 |
| 1USS55T | 5.5 | 0.81 | 1/4" | £1.95 |
| 1USS65T | 6.5 | 0.98 | 1/4" | £1.95 |
| 1USS8T | 8 | 1.63 | 1/4" | £1.95 |

Pozidriv Insert Bits

| Ref. | Tip | Hex Drive | Length mm | List £ |
|---------|-----|-----------|-----------|--------|
| 1UPZD0 | PZ0 | 1/4" | 25 | £1.71 |
| 1UPZD1T | PZ1 | 1/4" | 25 | £1.34 |
| 1UPZD2T | PZ2 | 1/4" | 25 | £1.34 |
| 1UPZD3T | PZ3 | 1/4" | 25 | £1.34 |
| 1UPZD4 | PZ4 | 1/4" | 25 | £4.28 |
| 2UPZD1 | PZ1 | 5/16" | 32 | £3.29 |
| 2UPZD2 | PZ2 | 5/16" | 32 | £3.29 |
| 2UPZD3 | PZ3 | 5/16" | 32 | £3.29 |
| 2UPZD4 | PZ4 | 5/16" | 32 | £3.29 |

Phillips Insert Bits

| Ref. | Tip | Hex Drive | Length mm | List £ |
|---------|-----|-----------|-----------|--------|
| 1UPHD1T | PH1 | 1/4" | 25 | £1.46 |
| 1UPHD2T | PH2 | 1/4" | 25 | £1.46 |
| 1UPHD3T | PH3 | 1/4" | 25 | £1.46 |
| 1UPHD4 | PH4 | 1/4" | 25 | £3.91 |

Magnetic Bit Holder

| Ref. | [F] Hex AF | [M] Hex AF | Length mm | List £ |
|------|------------|------------|-----------|--------|
| 1BHM | 1/4" | 1/4" | 50 | £9.29 |

Torx Insert Bits

| Ref. | Tip | Hex Drive | Length mm | List £ |
|--------|--------|-----------|-----------|--------|
| 1UTX6 | T x 6 | 1/4" | 25 | £5.13 |
| 1UTX7 | T x 7 | 1/4" | 25 | £5.13 |
| 1UTX8 | T x 8 | 1/4" | 25 | £5.13 |
| 1UTX9 | T x 9 | 1/4" | 25 | £5.13 |
| 1UTX10 | T x 10 | 1/4" | 25 | £5.13 |
| 1UTX15 | T x 15 | 1/4" | 25 | £5.13 |
| 1UTX20 | T x 20 | 1/4" | 25 | £5.13 |
| 1UTX25 | T x 25 | 1/4" | 25 | £3.97 |
| 1UTX27 | T x 27 | 1/4" | 27 | £3.97 |
| 1UTX30 | T x 30 | 1/4" | 30 | £3.97 |
| 1UTX40 | T x 40 | 1/4" | 40 | £3.97 |
| 2UTX25 | T x 25 | 5/16" | 35 | £5.56 |
| 2UTX30 | T x 30 | 5/16" | 35 | £5.73 |
| 2UTX40 | T x 40 | 5/16" | 35 | £5.87 |
| 2UTX45 | T x 45 | 5/16" | 35 | £6.00 |
| 2UTX50 | T x 50 | 5/16" | 35 | £6.11 |
| 2UTX55 | T x 55 | 5/16" | 35 | £6.42 |



Security Torx Insert Bits

| Ref. | Tip | Hex Drive | Length mm | List £ |
|---------|--------|-----------|-----------|--------|
| 1UTX10S | T x 10 | 1/4" | 25 | £4.64 |
| 1UTX15S | T x 15 | 1/4" | 25 | £4.64 |
| 1UTX20S | T x 20 | 1/4" | 25 | £4.64 |
| 1UTX25S | T x 25 | 1/4" | 25 | £4.64 |
| 1UTX27S | T x 27 | 1/4" | 25 | £4.64 |
| 1UTX30S | T x 30 | 1/4" | 25 | £4.64 |
| 1UTX40S | T x 40 | 1/4" | 25 | £4.64 |



Ball End Power Keys - Metric

| Ref. | Hex Size mm | Length mm | List £ |
|--------|-------------|-----------|--------|
| HPKB4 | 4 | 183 | £3.90 |
| HPKB5 | 5 | 183 | £4.16 |
| HPKB6 | 6 | 240 | £6.05 |
| HPKB8 | 8 | 240 | £7.89 |
| HPKB10 | 10 | 240 | £9.58 |



Power Keys - Metric

| Ref. | Hex Size mm | Length mm | List £ |
|--------|-------------|-----------|--------|
| HPK2 | 2 | 126 | £2.48 |
| HPK2.5 | 2.5 | 126 | £2.48 |
| HPK3 | 3 | 126 | £2.48 |
| HPK4 | 4 | 183 | £3.40 |
| HPK5 | 5 | 183 | £3.40 |
| HPK6 | 6 | 240 | £5.29 |
| HPK8 | 8 | 240 | £5.29 |
| HPK10 | 10 | 240 | £5.29 |

Power Keys - Torx

| Ref. | Tip | Length mm | List £ |
|-------|-----|-----------|--------|
| TPK10 | T10 | 126 | £3.70 |
| TPK15 | T15 | 126 | £3.77 |
| TPK20 | T20 | 126 | £4.63 |
| TPK25 | T25 | 133 | £4.91 |
| TPK27 | T27 | 133 | £5.05 |
| TPK30 | T30 | 190 | £7.51 |
| TPK40 | T40 | 190 | £8.21 |

Hexagon & Power Key Sets

Ball End



Standard



TPK8/TC

Hexagon Key Sets - Plastic Clip

| Ref. | Description | List £ |
|---------|---|--------|
| HKM9/C | 9 Piece Metric Key Set | £8.80 |
| HK9/C | 9 Piece AF Key Set | £7.67 |
| HKMB9/C | 9 Piece Metric Ball End Hexagon Key Set | £13.80 |
| HKB9/C | 9 Piece AF Ball End Hexagon Key Set | £12.55 |
| HKML9/C | 9 Piece Metric Long Reach Hexagon Key Set | £10.53 |
| HKL9/C | 9 Piece AF Long Reach Hexagon Key Set | £10.45 |

Power Key Sets

| Ref. | Contents | List £ |
|---------|------------------------------|--------|
| HPKM6/S | 6 Piece Metric Power Key Set | £20.19 |
| TPK6/S | 6 Piece Torx Power Key Set | £29.62 |

Power Key Sets - Hi-tech Foam

| Ref. | Contents | List £ |
|----------|---|--------|
| HPKM8/TC | 2, 2.5, 3, 4, 5, 6, 8, 10mm Hexagon Power Keys | £29.90 |
| TPK8/TC | T10, T15, T20, T25, T27, T30, T40 - Torx Power Keys | £37.46 |

Pliers





Combination Pliers

| Ref. | Length mm | Max wire dia.mm | List £ |
|-------|-----------|-----------------|--------|
| PG100 | 165 | 1.6 | £15.67 |
| PG101 | 180 | 1.8 | £16.47 |
| PG102 | 200 | 2.0 | £18.11 |



Diagonal Cutters

| Ref. | Length mm | Max wire dia.mm | List £ |
|-------|-----------|-----------------|--------|
| PG500 | 166 | 1.6 | £22.14 |
| PG501 | 187 | 1.8 | £24.41 |



Long Snipe Nose Plier

| Ref. | Length mm | Max wire dia.mm | List £ |
|--------|-----------|-----------------|--------|
| PG200L | 200 | 1.6 | £21.58 |



End Cutter

| Ref. | Length mm | Max wire dia.mm | List £ |
|-------|-----------|-----------------|--------|
| PG601 | 200 | 2 | £26.00 |



Bent Snipe Nose Plier

| Ref. | Length mm | Max wire dia.mm | List £ |
|---------|-----------|-----------------|--------|
| PG200LB | 194 | 1.6 | £22.14 |



Multigrip Plier

| Ref. | Length mm | Max Capacity | List £ |
|-------|-----------|--------------|--------|
| PG800 | 240 | 47 | £18.45 |

Circlip Pliers

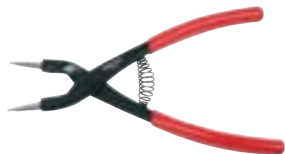

Straight Nose Internal

| Ref. | Length mm | Tip dia. mm | Size of Circlips mm | | List £ |
|------|-----------|-------------|---------------------|-----|--------|
| | | | Min | Max | |
| PC10 | 140 | 0.9 | 8 | 12 | £15.60 |
| PC11 | 140 | 1.3 | 12 | 25 | £14.38 |
| PC12 | 180 | 1.8 | 19 | 60 | £15.89 |
| PC13 | 215 | 2.3 | 40 | 100 | £18.45 |



Bent Nose Internal

| Ref. | Length mm | Tip dia. mm | Size of Circlips mm | | List £ |
|-------|-----------|-------------|---------------------|-----|--------|
| | | | Min | Max | |
| PC10B | 130 | 0.9 | 8 | 12 | £16.24 |
| PC11B | 130 | 1.3 | 12 | 25 | £15.02 |



Straight Nose External

| Ref. | Length mm | Tip dia. mm | Size of Circlips mm | | List £ |
|------|-----------|-------------|---------------------|-----|--------|
| | | | Min | Max | |
| PC20 | 145 | 0.9 | 3 | 10 | £15.31 |
| PC21 | 145 | 1.3 | 10 | 25 | £14.26 |
| PC22 | 180 | 1.8 | 19 | 60 | £15.72 |
| PC23 | 215 | 2.3 | 40 | 100 | £18.33 |



Bent Nose External

| Ref. | Length mm | Tip dia. mm | Size of Circlips mm | | List £ |
|-------|-----------|-------------|---------------------|-----|--------|
| | | | Min | Max | |
| PC20B | 130 | 0.9 | 3 | 10 | £16.07 |
| PC21B | 130 | 1.3 | 10 | 25 | £14.90 |
| PC22B | 170 | 1.8 | 19 | 60 | £16.30 |
| PC23B | 200 | 2.3 | 40 | 100 | £20.13 |



155mm Internal / External

| Ref. | Type | Size of Circlips mm | | Length | List £ |
|-------|----------|---------------------|-----|--------|--------|
| | | Min | Max | | |
| CPU21 | Internal | 8 | 26 | 155 | £37.04 |

Replacement Tips - 155mm

| Ref. | Type | Tip Sizes mm | List Price |
|----------|----------|---------------|------------|
| CPUTIP21 | Straight | 0.6, 0.9, 1.2 | £11.30 |
| | Bent 90° | 0.9, 1.2 | |



240mm Internal / External

| Ref. | Type | Size of Circlips mm | | Length | List £ |
|-------|----------|---------------------|-----|--------|--------|
| | | Min | Max | | |
| CPU65 | Internal | 31 | 100 | 240 | £80.80 |

Replacement Tips - 240mm

| Ref. | Type | Tip Sizes mm | List Price |
|----------|----------|---------------|------------|
| CPUTIP65 | Bent 15° | 2.3, 2.7, 3.0 | £16.86 |
| | Bent 90° | 2.3, 2.7, 3.0 | |

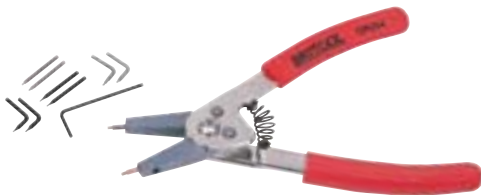

195mm Internal / External

| Ref. | Type | Size of Circlips mm | | Length | List £ |
|-------|----------|---------------------|-----|--------|--------|
| | | Min | Max | | |
| CPU34 | Internal | 10 | 48 | 195 | £41.19 |

Replacement Tips - 195mm

| Ref. | Type | Tip Sizes mm | List £ |
|----------|----------|---------------|--------|
| CPUTIP34 | Straight | 0.9, 1.2, 1.8 | £11.00 |
| | Bent 90° | 0.9, 1.2 | |

Miscellaneous Pliers



PM907



PM902



PM901

Lock Grip Plier

| Ref. | Jaw Shape | Length mm | Jaw capacity | List £ |
|-------|-----------|-----------|--------------|--------|
| PM900 | Curved | 190 | 42 | £17.86 |
| PM901 | Curved | 235 | 63 | £19.91 |
| PM902 | Straight | 190 | 42 | £15.07 |
| PM903 | Straight | 235 | 63 | £16.53 |
| PM906 | Long Nose | 150 | 37 | £14.71 |
| PM907 | Long Nose | 250 | 63 | £19.08 |



Wire Twisting Pliers

| Ref. | Length mm | Max wire mm | List £ |
|--------|-----------|-------------|--------|
| PMWT6 | 170 | 0.5 | £32.36 |
| PMWT10 | 241 | 0.5 | £33.69 |

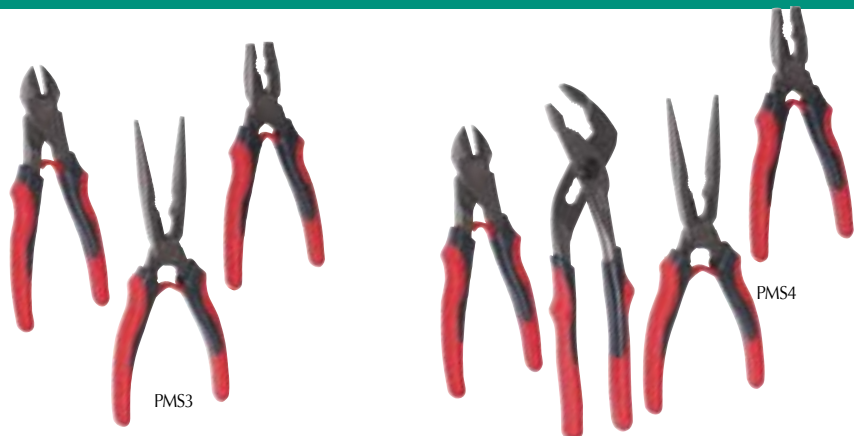

PMS3

PMS4



Engineers Plier Sets

| Part No | Description | Sizes | List £ |
|---------|-------------|--|--------|
| PMS3 | 3 Piece Set | 200mm Combination, 200mm Long Nose, 166mm Diagonal Cutter | £59.05 |
| PMS4 | 4 Piece Set | 200mm Combination, 200mm Long Nose, 166mm Diagonal Cutter, 240mm Multigrip Plier | £76.06 |

Interchangeable Circlip Plier Set

| Part No | Description | Sizes | List £ |
|---------|---|--|---------|
| CPUSET3 | 3 Piece Internal/External Interchangeable Plier Set | Internal: 8 - 100mm. External 3 - 100mm | £161.94 |



Engineers Plier Set - Hi-tech Foam

| Part No | Description | Sizes | List £ |
|----------|-------------|--|--------|
| PMS4/TC2 | 4 Piece Set | 200mm Combination, 200mm Long Nose, 166mm Diagonal Cutter, 240mm Multigrip | £76.06 |

Lock Grip Plier Set - Hi-tech Foam

| Part No | Description | Sizes | List £ |
|-----------|-----------------------------|---|--------|
| PMSET3/TC | 3 Piece Lock Grip Plier Set | Straight Jaw: 42mm, 63mm. Curved Jaw: 63mm | £52.32 |



PLIER2

PLIER3

Circlip Plier Sets

| Part No | Description | Sizes | List £ |
|---------|---------------------------------------|--|--------|
| PCS2 | 4 Piece 19 - 60 mm Circlip Plier Set | Bent Nose Internal/External. Straight Nose Internal/External | £61.40 |
| PCS3 | 4 Piece 40 - 100 mm Circlip Plier Set | Bent Nose Internal/External. Straight Nose Internal/External | £73.10 |



Micro Circlip Plier Set

| Ref. | Description | Sizes | List |
|-------|---------------------------------|--|--------|
| PMCS1 | 4 Piece micro circlip plier set | Bent Nose Internal/External. Straight Nose Internal/External | £14.19 |

3 Piece Plier Set

| Ref. | Description | Contents | List £ |
|--------|-------------------|---|--------|
| PLIER2 | 3 Piece Plier Set | 180 Combination Plier, 200mm Long Nose Plier, 166mm Side Cutter | £55.64 |
| PLIER3 | 3 Piece Plier Set | 180 Combination Plier, 200mm Long Nose Plier, 240mm Multigrip Plier | £51.10 |

Striking & Cutting



Hammers, Chisels & Punches



- Forged medium carbon steel construction
- Hickory handle – seasoned and kiln processed to ensure the correct moisture content
- Controlled heat treatment – ensuring the correct balance of hardening and tempering

Ball Pein Hammers - Hickory Handle

| Ref. | Size (oz) | Length mm | List £ |
|-------|-----------|-----------|--------|
| BPH4 | 4 | 275 | £10.36 |
| BPH8 | 8 | 300 | £12.05 |
| BPH16 | 16 | 350 | £13.91 |
| BPH24 | 24 | 375 | £16.69 |
| BPH32 | 32 | 400 | £18.57 |



- Ideal for heavy duty hammering where maximum but safe blows are required

Copper / Copper Hammers - Ash Handle

| Ref. | Weight (oz) | Hammer No. | Length mm | List £ |
|-------|-------------|------------|-----------|--------|
| CCH16 | 16 | A | 230 | £13.51 |
| CCH32 | 32 | 1 | 280 | £19.90 |
| CCH48 | 48 | 2 | 305 | £26.90 |
| CCH64 | 64 | 3 | 305 | £33.59 |



- Hickory handle – seasoned and kiln processed to ensure the correct moisture content

Nylon Soft Faced Hammers

| Ref. | Weight (oz) | Hammer No. | Length mm | List £ |
|-------|-------------|------------|-----------|--------|
| SFP16 | 16 | 32 | 280 | £18.15 |
| SFP24 | 24 | 38 | 305 | £20.84 |
| SFP32 | 32 | 44 | 305 | £24.61 |
| SFP44 | 44 | 50 | 330 | £33.27 |



- User adjustable impact strength
- Tips machined from S2 steel
- Brass knurled body for a comfortable secure grip

2 Piece Automatic Centre Punch Set

| Ref | Length mm | List £ |
|---------|-----------|--------|
| ACPSET1 | 125 | £23.85 |
| | 150 | |



Club Hammer

| Ref. | Size lbs | Length mm | List £ |
|------|----------|-----------|--------|
| MCH4 | 4 | 245 | £18.15 |



- An excellent dual purpose hammer for assembly and repair work

Copper / Rawhide Hammers - Ash Handle

| Ref. | Weight (oz) | Hammer No. | Length mm | List £ |
|-------|-------------|------------|-----------|--------|
| CRH14 | 14 | A | 230 | £16.07 |
| CRH24 | 24 | 1 | 280 | £22.52 |
| CRH40 | 40 | 2 | 305 | £28.78 |
| CRH56 | 56 | 3 | 305 | £36.02 |



- One piece design
- Shot filled steel head prevents rebound

Dead Blow Hammers

| Ref. | Size (oz) | Length mm | List £ |
|-------|-----------|-----------|--------|
| DBH18 | 18 | 290 | £9.65 |
| DBH42 | 42 | 380 | £18.70 |



- Contains 4 precision ground cold chisels

4 Piece Cold Chisel Set

| Ref | Length mm | Width mm | List £ |
|---------|-----------|----------|--------|
| CFCKET1 | 250 | 25 | £44.29 |
| | 200 | 20 | |
| | 190 | 15 | |
| | 180 | 10 | |



- The Britool HS212 hacksaw has a unique design which features a reversed bow. This allows extremely high blade tension levels up to 80kg to be applied progressively
- Blade tension levels of this magnitude are essential to gain the maximum benefit from bi-metal blades

| Reversed Bow Hacksaw | | | | | |
|----------------------|-----------|-----------|--------------|-----------------|--------|
| Ref. | Length mm | Height mm | Thickness mm | Blade Length mm | List £ |
| HS212 | 385 | 145 | 26 | 300 | £19.26 |



Front hand rest

Tensioning system

Two blade positions—45° and 90°

Minimum clearance needed to start cutting



Britool Professional Vices

- All forged, heavy duty steel construction for maximum longevity
- Precision machined for smooth fault free operation
- Integral anvil design
- Interchangeable jaws (excludes EV3)

| Britool Professional Vices | | | | |
|----------------------------|---------------|-----------------|---------------|------------|
| Ref. | Jaw Width(mm) | Jaw Opening(mm) | Jaw Depth(mm) | List Price |
| EV3 | 75 | 90 | 60 | £73.81 |
| EV4 | 100 | 100 | 60 | £96.52 |
| EV5 | 125 | 130 | 75 | £153.30 |
| EV6 | 150 | 190 | 90 | £232.79 |
| EV8 | 205 | 210 | 100 | £283.89 |

Pry Bars



- Powerful square section blade significantly reduces the spring effect often encountered with this style of pry bar
- Screwdriver style handles give a comfortable grip and significantly enhance the leverage which can be applied

Screwdriver Pry Bars

| Ref. | Blade Length mm | List £ |
|--------|-----------------|--------|
| SPB175 | 175 | £12.90 |
| SPB300 | 300 | £13.52 |
| SPB450 | 450 | £21.47 |
| SPB600 | 600 | £25.36 |



- These pry bars are forged from high quality chrome alloy steel and have a red powder coated finish
- Roll head acts as a fulcrum and increases the level of leverage which can be applied
- Used extensively in the automotive industry for leverage and location, particularly on brake assemblies

Roll Head Pry Bars

| Ref. | Length mm | Shank Diameter mm | List £ |
|------|-----------|-------------------|--------|
| 217 | 150 | 8 | £8.27 |
| 218 | 300 | 11 | £12.74 |
| 219 | 413 | 14.3 | £20.37 |



3 Piece Screwdriver Pry Bar Set

| Ref | Contents | List £ |
|--------|----------------------------|--------|
| SPBSET | SPB175 SPB300 SPB450 | £46.48 |

www.britool.com

VISIT THE BRITOOOL WEBSITE TO SEE THE LATEST PROMOTIONS, COMPETITIONS AND NEWS

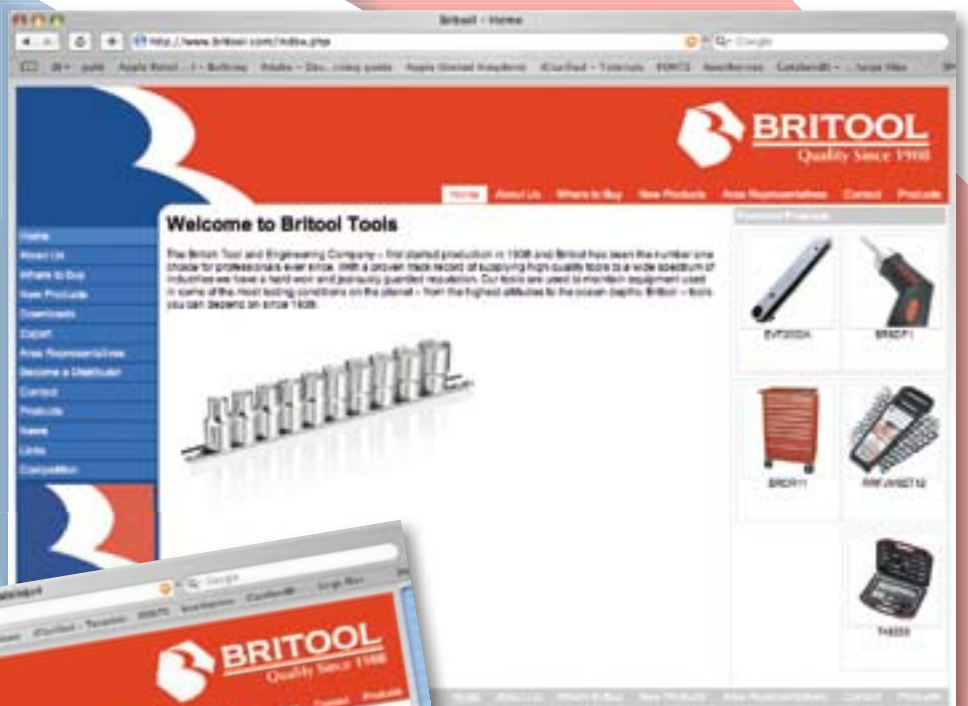

| | | |
|---------------------------------|--------------------|--|
| A | | |
| Accessories 1/4" sq. drive | 17 | |
| Accessories 1/2" sq. drive | 23, 24 | |
| Accessories 3/8" sq. drive | 20 | |
| Accessories 3/4" sq. drive | 28 | |
| Adjustable wrenches | 44 | |
| <hr/> | | |
| B | | |
| Bit holders | 50 | |
| Bits - insert | 50, 51 | |
| Boots | 60 | |
| <hr/> | | |
| C | | |
| C-hook wrenches | 44 | |
| Cantilever tool boxes | 12 | |
| Centre punches | 57 | |
| Chisels | 57 | |
| Circlip pliers | 53, 54 | |
| Combination wrenches | 37, 38, 39, 40, 41 | |
| <hr/> | | |
| E | | |
| Extension bars 1/4" sq. drive | 17 | |
| Extension bars 3/8" sq. drive | 20 | |
| Extension bars 1/2" sq. drive | 24 | |
| Extension bars mixed sq. drive | 27 | |
| <hr/> | | |
| H | | |
| Hacksaws | 58 | |
| Hammers - ball pein | 57 | |
| Hammers - claw | 57 | |
| Hammers - club | 57 | |
| Hammers - copper/ copper | 57 | |
| Hammers - dead blow | 57 | |
| Hammers - nylon faced | 57 | |
| Hand portable tool boxes | 12 | |
| Hexagon keys | 51 | |
| <hr/> | | |
| I | | |
| Impact sockets 3/8" sq. drive | 29 | |
| Impact sockets 1/2" sq. drive | 29 | |
| Insert bits | 50, 51 | |
| Insulated screwdrivers | 47 | |
| <hr/> | | |
| K | | |
| Keys - hexagon | 51 | |
| <hr/> | | |
| L | | |
| Lock grip pliers | 54 | |
| <hr/> | | |
| M | | |
| Mid sections | 8 | |
| <hr/> | | |
| O | | |
| Open jaw wrenches | 41, 42 | |
| <hr/> | | |
| P | | |
| Plier sets | 55 | |
| Pliers | 53, 54, 55 | |
| Pliers - bent nose | 53 | |
| Pliers - combination | 53 | |
| Pliers - long nose | 53 | |
| Pliers - multigrip | 53 | |
| Pliers - wire twisting | 54 | |
| Podger wrenches | 44 | |
| Power keys | 51 | |
| Pry bars | 59 | |
| <hr/> | | |
| R | | |
| Ratcheting combination wrenches | 37, 38 | |
| Ratcheting ring wrenches | 37, 38, 43 | |
| Ratcheting screwdrivers | 49 | |
| Ratchets 1/4" sq. drive | 17 | |
| Ratchets 3/8" sq. drive | 20 | |
| Ratchets 1/2" sq. drive | 23 | |
| Ratchets 3/4" sq. drive | 28 | |
| Ring wrenches | 42, 43 | |
| Ring wrenches - ratcheting | 37, 38, 43 | |
| Roller cabinets | 4, 5 | |
| <hr/> | | |
| S | | |
| Screwdrivers | 46, 47, 48, 49 | |
| Screwdrivers - flared tip | 46 | |
| Screwdrivers - insulated | 47 | |
| Screwdrivers - pozidriv | 47 | |
| Screwdrivers - phillips | 47 | |
| Screwdrivers - ratcheting | 49 | |
| Screwdrivers - stubby | 47 | |
| Screwdrivers - torx | 46 | |
| Side cabinets | 7 | |
| Side shelf | 8 | |
| Socket sets 1/4" sq. drive | 17, 18, 19 | |
| Socket sets 3/8" sq. drive | 21, 22 | |
| Socket sets 1/2" sq. drive | 24, 25, 26 | |
| Socket sets 3/4" sq. drive | 28 | |
| Socket sets mixed sq. drive | 27, 28 | |
| <hr/> | | |
| T | | |
| Tape measures | 59 | |
| Tool carts | 5 | |
| Tool chests | 6, 7 | |
| Toolkits | 9, 10, 11, 12 | |
| Torque drivers | 34 | |
| Torque multipliers | 34 | |
| Torque testers | 34 | |
| Torque wrenches - classic | 33 | |
| Torque wrenches - dial | 33 | |
| Torque wrenches - electronic | 33 | |
| Torque wrenches - series 2 | 33 | |
| <hr/> | | |
| V | | |
| Vices | 58 | |
| <hr/> | | |
| W | | |
| Work benches | 13 | |
| Work boots | 60 | |
| Wrenches - adjustable | 44 | |
| Wrenches - C-hook | 44 | |
| Wrenches - combination | 37, 38, 49, 40, 41 | |
| Wrenches - open jaw | 41, 42 | |
| Wrenches - podger | 44 | |
| Wrenches - ring | 42, 43 | |



| PART NO | LIST PRICE £ | Page No. | PART NO | LIST PRICE £ | Page No. | PART NO | LIST PRICE £ | Page No. |
|-----------|--------------|----------|---------|--------------|----------|------------|--------------|----------|
| BRRCR3 | £378.44 | 4 | AF45 | £41.96 | 20 | H70 | £41.33 | 28 |
| BRRCR5 | £420.49 | 4 | AFS20 | £38.61 | 20 | H74 | £158.04 | 28 |
| BRRCR6 | £510.59 | 4 | APES | £8.09 | 20 | 758200 | £21.58 | 29 |
| BRRCR6BL | £510.59 | 4 | ASEP | £8.23 | 20 | 758300 | £67.00 | 29 |
| BRRCR11 | £594.69 | 5 | A1UBA | £7.45 | 20 | 758500 | £78.35 | 29 |
| BRRCR11BL | £594.69 | 5 | CLIPA/2 | £0.23 | 20 | AVT100A | £100.66 | 33 |
| BRRCR7 | £548.21 | 5 | 708110 | £22.71 | 21 | AVT300A | £115.44 | 33 |
| BTCR16 | £1,051.22 | 5 | 708120 | £21.58 | 21 | AVT600 | £122.48 | 33 |
| BTBR10 | £420.49 | 6 | 708130 | £26.12 | 21 | EVT1200A | £128.85 | 33 |
| BTBR10BL | £420.49 | 6 | 708140 | £31.23 | 21 | EVT2000A | £152.09 | 33 |
| BTBR8W | £714.83 | 6 | 708310 | £6.76 | 21 | EVT3000A | £179.92 | 33 |
| BTBRD6 | £246.29 | 6 | 708320 | £6.76 | 21 | EVT600A | £122.48 | 33 |
| BSCR8 | £378.44 | 7 | 708330 | £6.76 | 21 | GVT8400 | £662.57 | 33 |
| BSCR8BL | £378.44 | 7 | 708340 | £6.76 | 21 | HVT5000 | £454.34 | 33 |
| BTBR8 | £276.32 | 7 | 708350 | £6.76 | 21 | HVT7200 | £454.34 | 33 |
| BTBRD6BL | £246.29 | 7 | 748262 | £36.34 | 21 | A50T | £128.04 | 34 |
| BMSR6 | £150.17 | 8 | 748263 | £62.46 | 21 | CM1000 | £1,305.97 | 34 |
| BMSR6BL | £150.17 | 8 | 748261 | £113.50 | 22 | CM40 | £1,051.46 | 34 |
| BSCR1 | £162.19 | 8 | 748264 | £51.10 | 22 | CM400 | £1,051.46 | 34 |
| BSCR1BL | £162.19 | 8 | 748267 | £130.59 | 22 | D25T | £128.04 | 34 |
| BCH1 | £22.83 | 9 | CLIPE/2 | £0.23 | 23 | E100T | £128.04 | 34 |
| BMSR8 | £618.72 | 9 | E70 | £17.69 | 23 | E200T | £145.50 | 34 |
| BSH1 | £30.03 | 9 | E74 | £42.89 | 23 | E340T | £161.80 | 34 |
| BSH1BL | £30.03 | 9 | E75 | £52.15 | 23 | EXT13 | £696.05 | 34 |
| BRKIT228 | £1,078.80 | 10 | E77 | £49.47 | 23 | HXT28 | £736.20 | 34 |
| BRKIT338 | £1,305.91 | 10 | E85 | £35.26 | 23 | RRJSMSET7 | £55.64 | 37 |
| BRKIT80 | £448.55 | 10 | E86 | £44.81 | 23 | RRMSET5 | £51.10 | 37 |
| BRKIT239 | £675.67 | 11 | E91 | £21.94 | 23 | RRSD3 | £9.03 | 39 |
| BRKIT314 | £1,470.57 | 11 | EF74 | £59.15 | 23 | RRTSET4 | £26.32 | 38 |
| BRKIT447 | £1,873.70 | 12 | EF520 | £43.15 | 23 | RRFJM10 | £11.36 | 38 |
| BRKIT470 | £2,492.59 | 13 | EPHS | £16.39 | 23 | RRFJM11 | £11.36 | 38 |
| CTB45 | £29.94 | 13 | ESHIP | £12.04 | 23 | RRFJM12 | £11.36 | 38 |
| 708275 | £5.62 | 17 | PR250 | £1.36 | 23 | RRFJM13 | £12.49 | 38 |
| 708280 | £5.62 | 17 | PR450 | £5.68 | 23 | RRFJM14 | £12.49 | 38 |
| 708290 | £5.62 | 17 | 708220 | £39.75 | 24 | RRFJM15 | £13.06 | 38 |
| 708300 | £5.62 | 17 | 708230 | £39.75 | 24 | RRFJM16 | £13.63 | 38 |
| 708510 | £7.38 | 17 | 708260 | £21.58 | 24 | RRFJM17 | £14.76 | 38 |
| D46 | £32.81 | 17 | 708270 | £23.85 | 24 | RRFJM18 | £15.90 | 38 |
| D70 | £10.90 | 17 | 708360 | £7.89 | 24 | RRFJM19 | £15.90 | 38 |
| D77 | £36.67 | 17 | 708370 | £7.89 | 24 | RRFJM8 | £11.36 | 38 |
| D91 | £20.27 | 17 | 708380 | £7.89 | 24 | RRFJM9 | £11.36 | 38 |
| DFS20 | £28.39 | 17 | 708390 | £8.46 | 24 | RRFJMSET12 | £153.30 | 37 |
| DPAS | £10.95 | 17 | 708400 | £11.30 | 24 | RRJM10 | £9.08 | 38 |
| D1UBA | £6.93 | 17 | 708530 | £12.49 | 24 | RRJM11 | £9.08 | 38 |
| DSAP | £8.15 | 17 | 708240 | £24.98 | 25 | RRJM12 | £10.22 | 38 |
| 708010 | £21.58 | 18 | 748275 | £51.10 | 25 | RRJM13 | £10.22 | 38 |
| 708020 | £17.03 | 18 | 748276 | £32.93 | 25 | RRJM14 | £10.79 | 38 |
| 708030 | £20.44 | 18 | 748277 | £31.80 | 25 | RRJM15 | £10.79 | 38 |
| 708040 | £13.63 | 18 | 748271 | £102.14 | 26 | RRJM16 | £12.49 | 38 |
| 748251 | £36.34 | 18 | 748272 | £124.91 | 26 | RRJM17 | £12.49 | 38 |
| 748252 | £55.64 | 18 | 748273 | £101.07 | 26 | RRJM18 | £12.49 | 38 |
| 748254 | £62.46 | 19 | 748274 | £136.27 | 26 | RRJM19 | £13.06 | 38 |
| 748255 | £73.81 | 19 | 708410 | £32.93 | 27 | RRJM8 | £9.08 | 38 |
| 748256 | £90.85 | 19 | 708420 | £23.85 | 27 | RRJM9 | £9.08 | 38 |
| 708520 | £9.65 | 20 | 708430 | £24.98 | 27 | RRJMSET1 | £124.91 | 37 |
| A45 | £38.53 | 20 | 708540 | £14.19 | 27 | RRJMSET12F | £103.95 | 38 |
| A46 | £47.84 | 20 | 708550 | £15.90 | 27 | RRJSM10 | £6.53 | 38 |
| A70 | £12.92 | 20 | 748293 | £124.91 | 27 | RRJSM12 | £7.38 | 38 |
| A77 | £43.00 | 20 | 748289 | £261.18 | 28 | RRJSM13 | £7.38 | 38 |
| A91 | £20.89 | 20 | 748291 | £157.84 | 28 | RRJSM14 | £7.95 | 38 |

Numerical Index & Prices

| PART NO | LIST PRICE £ | Page No. | PART NO | LIST PRICE £ | Page No. | PART NO | LIST PRICE £ | Page No. |
|---------|--------------|----------|--------------|--------------|----------|------------|--------------|----------|
| RRJSM15 | £7.95 | 38 | RJM21 | £12.51 | 39 | 2J168187 | £52.67 | 41 |
| RRJSM17 | £10.22 | 38 | RJM22 | £14.26 | 39 | 2J186205 | £81.90 | 41 |
| RRJSM19 | £10.22 | 38 | RJM23 | £15.42 | 39 | 2J2531 | £4.30 | 41 |
| RRM1011 | £10.16 | 38 | RJM24 | £16.13 | 39 | 2J3137 | £4.43 | 41 |
| RRM1213 | £11.36 | 38 | RJM25 | £17.86 | 39 | 2J3344 | £6.63 | 41 |
| RRM1415 | £12.50 | 38 | RJM26 | £20.66 | 39 | 2J3743 | £4.77 | 41 |
| RRM1719 | £13.63 | 38 | RJM27 | £21.12 | 39 | 2J4350 | £5.53 | 41 |
| RRM810 | £10.16 | 38 | RJM28 | £25.31 | 39 | 2J4452 | £7.30 | 41 |
| RJ1000 | £17.90 | 39 | RJM30 | £27.99 | 39 | 2J5056 | £5.94 | 41 |
| RJ1010 | £25.65 | 39 | RJM32 | £31.60 | 39 | 2J5260 | £7.86 | 41 |
| RJ1062 | £19.58 | 39 | RJM34 | £45.98 | 39 | 2J5662 | £6.00 | 41 |
| RJ1100 | £34.40 | 39 | RJM36 | £48.59 | 39 | 2J5668 | £6.35 | 41 |
| RJ1125 | £25.86 | 39 | RJM41 | £65.13 | 39 | 2J6071 | £9.33 | 41 |
| RJ1200 | £38.12 | 39 | RJM46 | £90.15 | 39 | 2J6268 | £6.57 | 41 |
| RJ1250 | £30.67 | 39 | RJM50 | £110.58 | 39 | 2J6275 | £7.80 | 41 |
| RJ1300 | £51.32 | 39 | RJM55 | £156.49 | 39 | 2J6875 | £7.80 | 41 |
| RJ1312 | £40.49 | 39 | RJM6 | £5.53 | 39 | 2J7182 | £11.57 | 41 |
| RJ1375 | £48.22 | 39 | RJM60 | £214.17 | 39 | 2J7587 | £8.62 | 41 |
| RJ1437 | £49.48 | 39 | RJM65 | £259.57 | 39 | 2J8187 | £9.25 | 41 |
| RJ1480 | £79.02 | 39 | RJM7 | £5.53 | 39 | 2J8193 | £9.61 | 41 |
| RJ1500 | £60.64 | 39 | RJM8 | £5.53 | 39 | 2J8292 | £13.77 | 41 |
| RJ1625 | £68.36 | 39 | RJM9 | £5.53 | 39 | 2J92101 | £17.15 | 41 |
| RJ1687 | £75.37 | 39 | ND130A | £74.21 | 40 | 2J93100 | £13.91 | 41 |
| RJ1750 | £75.37 | 39 | ND150J | £219.80 | 40 | 2J93112 | £18.74 | 41 |
| RJ1812 | £113.49 | 39 | ND243L | £92.95 | 40 | 2JM1011 | £4.71 | 41 |
| RJ1875 | £113.49 | 39 | ND251D | £192.64 | 40 | 2JM1013 | £5.53 | 41 |
| RJ248 | £7.19 | 39 | ND360E | £141.31 | 40 | 2JM1213 | £5.53 | 41 |
| RJ250 | £5.67 | 39 | RJ10/STC | £57.62 | 41 | 2JM1317 | £6.46 | 41 |
| RJ312 | £5.67 | 39 | RJM10/STC | £56.97 | 41 | 2JM1415 | £6.46 | 41 |
| RJ324 | £7.20 | 39 | RJMSET11 | £68.25 | 40 | 2JM1617 | £6.46 | 41 |
| RJ338 | £7.93 | 39 | RJMSET14/TC | £82.95 | 40 | 2JM1719 | £7.56 | 41 |
| RJ344 | £5.67 | 39 | RJMSET7L/TC | £89.25 | 40 | 2JM1819 | £7.56 | 41 |
| RJ375 | £5.67 | 39 | RJMSET8 | £46.20 | 40 | 2JM1922 | £9.48 | 41 |
| RJ413 | £7.20 | 39 | RJSET8 | £50.40 | 40 | 2JM2022 | £10.65 | 41 |
| RJ437 | £5.90 | 39 | RJSMSET7 | £40.95 | 40 | 2JM2123 | £10.65 | 41 |
| RJ445 | £7.93 | 39 | RJXM10 | £10.77 | 39 | 2JM2224 | £13.67 | 41 |
| RJ500 | £5.90 | 39 | RJXM11 | £11.00 | 39 | 2JM2426 | £15.34 | 41 |
| RJ525 | £8.96 | 39 | RJXM12 | £11.17 | 39 | 2JM2427 | £19.23 | 41 |
| RJ562 | £6.86 | 39 | RJXM13 | £11.81 | 39 | 2JM2430 | £22.23 | 41 |
| RJ600 | £10.48 | 39 | RJXM14 | £12.22 | 39 | 2JM2730 | £22.68 | 41 |
| RJ625 | £7.76 | 39 | RJXM15 | £12.87 | 39 | 2JM3032 | £23.80 | 41 |
| RJ687 | £8.95 | 39 | RJXM16 | £13.67 | 39 | 2JM3236 | £30.38 | 41 |
| RJ710 | £12.20 | 39 | RJXM17 | £14.90 | 39 | 2JM3641 | £47.35 | 41 |
| RJ750 | £8.95 | 39 | RJXM18 | £15.77 | 39 | 2JM67 | £4.71 | 41 |
| RJ812 | £13.72 | 39 | RJXM19 | £17.17 | 39 | 2JM78 | £4.71 | 41 |
| RJ820 | £15.14 | 39 | RJXM7/S | £84.79 | 41 | 2JM810 | £4.71 | 41 |
| RJ875 | £14.91 | 39 | RJXM7/S19 | £89.22 | 41 | 2JM89 | £4.71 | 41 |
| RJ920 | £19.45 | 39 | RJXM7/STC | £89.22 | 41 | 5J1013 | £4.59 | 41 |
| RJ937 | £16.27 | 39 | RJXMSET10 | £103.95 | 41 | 5J1115 | £4.62 | 41 |
| RJM10 | £5.94 | 39 | RJXMSET10/TC | £103.95 | 40 | 5J1722 | £4.62 | 41 |
| RJM11 | £5.94 | 39 | 2J101110 | £22.48 | 41 | 5J1924 | £4.62 | 41 |
| RJM12 | £5.94 | 39 | 2J101120 | £27.83 | 41 | 5J2432 | £4.62 | 41 |
| RJM13 | £6.81 | 39 | 2J106112 | £19.50 | 41 | 5J2836 | £5.08 | 41 |
| RJM14 | £6.81 | 39 | 2J106125 | £20.84 | 41 | 5J3241 | £5.13 | 41 |
| RJM15 | £7.74 | 39 | 2J120130 | £33.44 | 41 | 2JMSET8/TC | £37.80 | 42 |
| RJM16 | £7.74 | 39 | 2J125143 | £31.77 | 41 | 9RBM1011 | £7.18 | 42 |
| RJM17 | £8.96 | 39 | 2J130148 | £49.90 | 41 | 9RBM1213 | £7.57 | 42 |
| RJM18 | £8.96 | 39 | 2J131150 | £33.93 | 41 | 9RBM1415 | £8.01 | 42 |
| RJM19 | £10.41 | 39 | 2J148167 | £69.74 | 41 | 9RBM1617 | £8.69 | 42 |
| RJM20 | £11.88 | 39 | 2J162181 | £50.99 | 41 | 9RBM1819 | £10.06 | 42 |

| PART NO | LIST PRICE £ | Page No. | PART NO | LIST PRICE £ | Page No. | PART NO | LIST PRICE £ | Page No. |
|-----------------|--------------|----------|------------|--------------|----------|----------|--------------|----------|
| 9RBM67 | £6.27 | 42 | RRPM1719 | £19.30 | 44 | SM75PZ1 | £4.77 | 47 |
| 9RBM89 | £6.65 | 42 | RRPM1921 | £21.58 | 44 | SDRIV1 | £36.34 | 48 |
| NB108T | £24.45 | 42 | RRPM2427 | £26.12 | 44 | SDRIV2 | £42.58 | 48 |
| NB131R | £69.71 | 42 | SM100/5.5 | £4.60 | 46 | SDRIV3 | £36.34 | 48 |
| NB141C | £119.71 | 42 | SM100T20 | £6.42 | 46 | SDRIV4 | £34.07 | 48 |
| NB227D | £44.70 | 42 | SM100T25 | £7.63 | 46 | SDRIV5 | £42.58 | 48 |
| NB231E | £40.10 | 42 | SM100T27 | £7.63 | 46 | SDRIV6 | £29.63 | 48 |
| NB250P | £65.01 | 42 | SM100TPT20 | £6.47 | 46 | SDS11 | £59.95 | 48 |
| NB351G | £91.20 | 42 | SM100TPT25 | £7.72 | 46 | SDS5 | £26.19 | 48 |
| NC381T | £53.25 | 43 | SM100TPT27 | £7.95 | 46 | SDS6 | £31.80 | 48 |
| NC391T/TC | £65.18 | 42 | SM125/6.5 | £6.22 | 46 | SDS7 | £34.07 | 48 |
| RRBMSET7/TC | £47.25 | 43 | SM125T30 | £7.88 | 46 | SDS7/2TC | £46.50 | 48 |
| RRLMSET3 | £51.45 | 43 | SM125T40 | £9.65 | 46 | SDS8/TC | £37.67 | 48 |
| S2JM10 | £42.66 | 42 | SM125TPT30 | £7.95 | 46 | SDS9/TC | £41.85 | 48 |
| RBB1112 | £15.49 | 43 | SM125TPT40 | £9.65 | 46 | SL4/S | £19.25 | 48 |
| RBB1314 | £15.49 | 43 | SM150/6.5 | £6.35 | 46 | SL6/S | £14.91 | 48 |
| RBB1517 | £18.57 | 43 | SM150/8 | £8.27 | 46 | SL8/S | £15.46 | 48 |
| RBB1618 | £18.57 | 43 | SM200/10 | £10.59 | 46 | BCSD1 | £9.03 | 49 |
| RBB1921 | £20.59 | 43 | SM250/12 | £12.22 | 46 | BCSD2 | £7.89 | 49 |
| RBB2531 | £9.94 | 43 | SM250/8 | £8.73 | 46 | BCSD3 | £10.79 | 49 |
| RBB3743 | £11.72 | 43 | SM75PZ0 | £4.19 | 46 | BRSD2 | £20.44 | 49 |
| RBB4350 | £17.76 | 43 | SM75T10 | £4.70 | 46 | BRSDF1 | £25.55 | 49 |
| RBB5056 | £17.20 | 43 | SM75T15 | £5.38 | 46 | BRSDSET1 | £51.10 | 49 |
| RBB5662 | £19.76 | 43 | SM75TPT10 | £4.77 | 46 | BRSDSET2 | £23.85 | 49 |
| RBB6268 | £19.58 | 43 | SM75TPT15 | £5.45 | 46 | 1BHM | £9.29 | 50 |
| RBB7587 | £19.92 | 43 | SE100/3.5 | £3.20 | 47 | 1UPHD1T | £1.46 | 50 |
| RBB78 | £10.88 | 43 | SE100/4 | £3.20 | 47 | 1UPHD2T | £1.46 | 50 |
| RBB910 | £12.22 | 43 | SE100PH1 | £4.19 | 47 | 1UPHD3T | £1.46 | 50 |
| RBMSET/TC | £108.19 | 44 | SE125PH2 | £6.22 | 47 | 1UPHD4 | £3.91 | 50 |
| RBO2531 | £11.15 | 43 | SE150/4 | £3.96 | 47 | 1UPZD0 | £1.71 | 50 |
| RBO3743 | £12.65 | 43 | SE150/5.5 | £4.25 | 47 | 1UPZD1T | £1.34 | 50 |
| RBO5056 | £18.93 | 43 | SE150PH3 | £8.55 | 47 | 1UPZD2T | £1.34 | 50 |
| RBO6268 | £21.14 | 43 | SE175/6.5 | £4.95 | 47 | 1UPZD3T | £1.34 | 50 |
| RBO7587 | £21.63 | 43 | SE200PH4 | £11.23 | 47 | 1UPZD4 | £4.28 | 50 |
| RBOM1112 | £17.49 | 43 | SE250/5 | £4.60 | 47 | 1USB093 | £4.04 | 50 |
| RBOM1314 | £17.49 | 43 | SE30/4 | £3.67 | 47 | 1USB125 | £4.04 | 50 |
| RBOM1517 | £20.47 | 43 | SE30/5.5 | £3.72 | 47 | 1USB156 | £4.04 | 50 |
| RBOM1921 | £22.54 | 43 | SE30/6.5 | £3.84 | 47 | 1USB187 | £4.04 | 50 |
| RBOM78 | £11.92 | 43 | SE30PH1 | £4.19 | 47 | 1USB250 | £4.04 | 50 |
| RBOM910 | £13.77 | 43 | SE30PH2 | £4.30 | 47 | 1USB25M | £2.99 | 50 |
| RBOMSET | £77.24 | 44 | SE50/2.5 | £2.27 | 47 | 1USB2M | £2.99 | 50 |
| RBOMSET/TC | £99.93 | 44 | SE50/3 | £2.44 | 47 | 1USB3M | £4.04 | 50 |
| RBOSET | £75.37 | 44 | SE50PH00 | £2.50 | 47 | 1USB4M | £3.97 | 50 |
| RBSET/TC | £113.49 | 44 | SE75/3.5 | £2.62 | 47 | 1USB5M | £4.21 | 50 |
| RCH- WRENCH1 | £81.76 | 44 | SE75PH0 | £2.79 | 47 | 1USB6M | £4.21 | 50 |
| 3150 | £18.42 | 44 | SE75PH1 | £3.69 | 47 | 1USS45T | £1.95 | 50 |
| 3151 | £25.44 | 44 | SES100/3.5 | £3.90 | 47 | 1USS4T | £1.95 | 50 |
| 3152 | £33.50 | 44 | SES100PH1 | £6.05 | 47 | 1USS55T | £1.95 | 50 |
| 306C | £19.20 | 44 | SES125PH2 | £8.55 | 47 | 1USS65T | £1.95 | 50 |
| 308C | £22.40 | 44 | SES150/4 | £5.18 | 47 | 1USS8T | £1.95 | 50 |
| 310C | £27.41 | 44 | SES175/5.5 | £6.81 | 47 | 2UPZD1 | £3.29 | 50 |
| 312C | £36.82 | 44 | SES50/2.5 | £3.43 | 47 | 2UPZD2 | £3.29 | 50 |
| 315C | £59.78 | 44 | SES50PH00 | £3.55 | 47 | 2UPZD3 | £3.29 | 50 |
| 318C | £105.14 | 44 | SES75PH0 | £4.08 | 47 | 2UPZD4 | £3.29 | 50 |
| PW200 | £20.51 | 44 | SM100PZ1 | £5.29 | 47 | 2USB187 | £4.39 | 50 |
| PW250 | £23.94 | 44 | SM125PZ2 | £7.34 | 47 | 2USB218 | £4.39 | 50 |
| PW300 | £27.65 | 44 | SM150PZ3 | £9.66 | 47 | 2USB250 | £4.89 | 50 |
| PW350 | £31.70 | 44 | SM200PZ4 | £12.22 | 47 | 2USB312 | £4.89 | 50 |
| PW450 | £45.37 | 44 | SM30PZ1 | £4.89 | 47 | 2USB5M | £5.01 | 50 |
| | | | SM30PZ2 | £5.06 | 47 | 2USB6M | £5.01 | 50 |

Numerical Index & Prices

| PART NO | LIST PRICE £ | Page No. | PART NO | LIST PRICE £ | Page No. | PART NO | LIST PRICE £ | Page No. |
|----------|--------------|----------|-----------|--------------|----------|---------|--------------|----------|
| 2USB8M | £5.80 | 50 | TPK15 | £3.77 | 51 | BPH40 | £24.68 | 57 |
| 2USS5 | £4.89 | 50 | TPK20 | £4.63 | 51 | BPH8 | £12.05 | 57 |
| 2USS6 | £5.19 | 50 | TPK25 | £4.91 | 51 | CCH16 | £13.51 | 57 |
| 2USS7 | £5.19 | 50 | TPK27 | £5.05 | 51 | CCH32 | £19.90 | 57 |
| 3USB10M | £7.27 | 50 | TPK30 | £7.51 | 51 | CCH48 | £26.90 | 57 |
| 3USB12M | £7.27 | 50 | TPK40 | £8.21 | 51 | CCH64 | £33.59 | 57 |
| 3USB14M | £7.27 | 50 | TPK6/S | £29.62 | 51 | CFCSET1 | £44.29 | 57 |
| 3USB375 | £7.27 | 50 | TPK8/TC | £37.46 | 51 | CRH14 | £16.07 | 57 |
| 3USB500 | £7.27 | 50 | PC10 | £15.60 | 53 | CRH24 | £22.52 | 57 |
| 3USB562 | £7.27 | 50 | PC10B | £16.24 | 53 | CRH40 | £28.78 | 57 |
| A1UBA | £7.45 | 50 | PC11 | £14.38 | 53 | CRH56 | £36.02 | 57 |
| BBS109 | £51.10 | 50 | PC11B | £15.02 | 53 | DBH18 | £9.65 | 57 |
| BBS31 | £14.19 | 50 | PC12 | £15.89 | 53 | DBH42 | £18.74 | 57 |
| D1UBA | £6.93 | 50 | PC13 | £18.45 | 53 | MCH4 | £18.17 | 57 |
| 1UTX10 | £5.13 | 51 | PC20 | £15.31 | 53 | SFP16 | £18.15 | 57 |
| 1UTX10S | £4.64 | 51 | PC20B | £16.07 | 53 | SFP24 | £20.84 | 57 |
| 1UTX15 | £5.13 | 51 | PC21 | £14.26 | 53 | SFP32 | £24.61 | 57 |
| 1UTX15S | £4.64 | 51 | PC21B | £14.90 | 53 | SFP44 | £33.27 | 57 |
| 1UTX20 | £5.02 | 51 | PC22 | £15.72 | 53 | EV3 | £73.81 | 58 |
| 1UTX20S | £4.64 | 51 | PC22B | £16.30 | 53 | EV4 | £96.52 | 58 |
| 1UTX25 | £3.97 | 51 | PC23 | £18.33 | 53 | EV5 | £153.30 | 58 |
| 1UTX25S | £4.64 | 51 | PC23B | £20.13 | 53 | EV6 | £232.79 | 58 |
| 1UTX27 | £3.97 | 51 | PG100 | £15.67 | 53 | EV8 | £283.89 | 58 |
| 1UTX27S | £4.64 | 51 | PG101 | £16.47 | 53 | HS212 | £19.26 | 58 |
| 1UTX30 | £3.97 | 51 | PG102 | £18.11 | 53 | 217 | £8.27 | 59 |
| 1UTX30S | £4.64 | 51 | PG200L | £21.58 | 53 | 218 | £12.74 | 59 |
| 1UTX40 | £3.97 | 51 | PG200LB | £22.14 | 53 | 219 | £20.37 | 59 |
| 1UTX40S | £4.64 | 51 | PG500 | £22.14 | 53 | SPB175 | £12.90 | 59 |
| 1UTX6 | £5.13 | 51 | PG501 | £24.41 | 53 | SPB300 | £13.52 | 59 |
| 1UTX7 | £5.13 | 51 | PG601 | £26.00 | 53 | SPB450 | £21.47 | 59 |
| 1UTX8 | £5.13 | 51 | PG800 | £18.45 | 53 | SPB600 | £25.36 | 59 |
| 1UTX9 | £5.13 | 51 | CPU21 | £37.04 | 54 | SPBSET | £46.48 | 59 |
| 2UTX25 | £5.56 | 51 | CPU34 | £41.19 | 54 | | | |
| 2UTX30 | £5.73 | 51 | CPU65 | £80.80 | 54 | | | |
| 2UTX40 | £5.87 | 51 | CPUTIP21 | £11.30 | 54 | | | |
| 2UTX45 | £6.00 | 51 | CPUTIP34 | £11.00 | 54 | | | |
| 2UTX50 | £6.11 | 51 | CPUTIP65 | £16.86 | 54 | | | |
| 2UTX55 | £6.42 | 51 | PM900 | £17.86 | 54 | | | |
| HK9/C | £7.67 | 51 | PM901 | £19.91 | 54 | | | |
| HKB9/C | £12.55 | 51 | PM902 | £15.07 | 54 | | | |
| HKL9/C | £10.45 | 51 | PM903 | £16.53 | 54 | | | |
| HKM9/C | £8.80 | 51 | PM906 | £14.71 | 54 | | | |
| HKMB9/C | £13.80 | 51 | PM907 | £19.08 | 54 | | | |
| HKML9/C | £10.33 | 51 | PMWT10 | £33.69 | 54 | | | |
| HPK10 | £5.29 | 51 | PMWT6 | £32.36 | 54 | | | |
| HPK2 | £2.48 | 51 | CPUSET3 | £161.94 | 55 | | | |
| HPK2.5 | £2.48 | 51 | PCS2 | £61.40 | 55 | | | |
| HPK3 | £2.48 | 51 | PCS3 | £73.10 | 55 | | | |
| HPK4 | £3.40 | 51 | PLIER2 | £55.64 | 55 | | | |
| HPK5 | £3.40 | 51 | PLIER3 | £51.10 | 55 | | | |
| HPK6 | £5.29 | 51 | PMCS1 | £14.19 | 55 | | | |
| HPK8 | £5.29 | 51 | PMS3 | £59.05 | 55 | | | |
| HPKB10 | £9.58 | 51 | PMS4 | £76.06 | 55 | | | |
| HPKB4 | £3.90 | 51 | PMS4/TC | £76.06 | 55 | | | |
| HPKB5 | £4.16 | 51 | PMSET3/TC | £52.32 | 55 | | | |
| HPKB6 | £6.05 | 51 | ACPSET1 | £23.85 | 57 | | | |
| HPKB8 | £7.89 | 51 | BPH16 | £13.91 | 57 | | | |
| HPKM6/S | £20.19 | 51 | BPH24 | £16.59 | 57 | | | |
| HPKM8/TC | £29.90 | 51 | BPH32 | £18.57 | 57 | | | |
| TPK10 | £3.70 | 51 | BPH4 | £10.36 | 57 | | | |

The Britool Guarantee

General Terms

1. All products are guaranteed to perform the task for which they were designed, provided they are used under normal working conditions.
2. This guarantee is in addition to your statutory rights.
3. This guarantee is without time limit, except in cases of:
 - a. Fair wear and tear.
 - b. Wilful damage or misuse.
 - c. Negligence (including failure to adhere to instructions for use or other recommendations made by the Company).
 - d. Alterations and unauthorized repairs.
 - e. Where products have a specified fixed period of guarantee, as indicated in the published price list, or in documentation supplied with the product.
 - f. Consumables, which are subject to the legal statutory guarantee only.
4. The guarantee offers a free of charge exchange or repair, limited to defective parts only.
5. Products no longer in the range will be replaced by an equivalent product or refunded if there is no equivalent available, at the Company's discretion.
6. The guarantee gives no right to damages for loss, or consequential loss under any circumstances.

Specific Terms Applicable To The Guarantee

1. Moving parts (eg ratchet mechanisms) which are subject to wear and tear have a fixed period of guarantee. Products containing moving parts will be replaced during the guarantee period only. Thereafter, a chargeable repair or reconditioned unit will be offered.
2. Electronic products, which have a fixed period of guarantee will be replaced or repaired at the company's discretion, during the guarantee period only. Thereafter a chargeable repair or reconditioned unit will be offered. The guarantee does not include upgrades to software based products.
3. Toolboxes, roller cabinets and workbenches, unless otherwise stated are subject to the statutory guarantee. Moving parts will only be replaced or repaired under the terms of the guarantee.
4. Products with valves, seals, O-rings, etc are subject to a specified fixed period guarantee, outside of which standard repair charges will apply.
5. For products issued with a Certificate of Calibration, the maintenance of the accuracy of such calibration is outside the scope of the guarantee.

