



MMA-MIG

CONVERTER KIT

00587



These instructions accompanying the product are the original instructions. This document is part of the product, keep it for the life of the product passing it on to any subsequent holder of the product. Read all these instructions before assembling, operating or maintaining this product.

This manual has been compiled by Draper Tools describing the purpose for which the product has been designed, and contains all the necessary information to ensure its correct and safe use. By following all the general safety instructions contained in this manual, it will ensure both product and operator safety, together with longer life of the product itself.

All photographs and drawings in this manual are supplied by Draper Tools to help illustrate the operation of the product.

Whilst every effort has been made to ensure the accuracy of information contained in this manual, the Draper Tools policy of continuous improvement determines the right to make modifications without prior warning.

1. TITLE PAGE

1.1 INTRODUCTION:

USER MANUAL FOR: MMA-MIG Converter Kit

Stock No: 00587

Part No: MCB200

1.2 REVISIONS:

Date first published September 2018.

As our user manuals are continually updated, users should make sure that they use the very latest version.

Downloads are available from: <http://drapertools.com/manuals>

Draper Tools Limited

Hursley Road

Chandler's Ford

Eastleigh

Hampshire

SO53 1YF

UK

Website: drapertools.com

Product Helpline: +44 (0) 23 8049 4344

General Fax: +44 (0) 23 8026 0784

1.3 UNDERSTANDING THIS MANUALS SAFETY CONTENT:

WARNING! – Information that draws attention to the risk of injury or death.

CAUTION! – Information that draws attention to the risk of damage to the product or surroundings.

1.4 COPYRIGHT © NOTICE:

Copyright © Draper Tools Limited.

Permission is granted to reproduce this publication for personal and educational use only. Commercial copying, redistribution, hiring or lending is prohibited.

No part of this publication may be stored in a retrieval system or transmitted in any other form or means without written permission from Draper Tools Limited.

In all cases this copyright notice must remain intact.

2. CONTENTS

1. TITLE PAGE

1.1 INTRODUCTION.....	2
1.2 REVISION HISTORY	2
1.3 UNDERSTANDING THIS MANUAL	2
1.4 COPYRIGHT NOTICE	2

2. CONTENTS

2.1 CONTENTS	3
--------------------	---

3. WARRANTY

3.1 WARRANTY.....	4
-------------------	---

4. INTRODUCTION

4.1 SCOPE.....	5
4.2 SPECIFICATION	5
4.3 HANDLING AND STORAGE.....	5

5. HEALTH AND SAFETY INFORMATION

5.1 GENERAL SAFETY INSTRUCTIONS FOR POWER TOOL USE	6-7
5.2 CONNECTION TO THE POWER SUPPLY	7

6. TECHNICAL DESCRIPTION

6.1 IDENTIFICATION	8
--------------------------	---

7. UNPACKING AND CHECKING

7.1 PACKAGING	9
7.2 WHAT'S IN THE BOX?.....	9

8. PREPARING THE WELDER

8.1 OTHER TOOLS NEEDED IN CONJUNCTION WITH CONVERTER KIT.....	10
8.2 GENERAL	10
8.3 LOCATION	10
8.4 INSTALLING THE FILLER WIRE	11-13

9. BASIC WELDING OPERATION

9.1 MIG WIRE SPEED ADJUSTMENT.....	14
9.2 MIG WELDING PRINCIPLES	14
9.3 DEFINITION	15
9.4 THERMAL CUT-OUT INDICATOR	15

10. OPTIONAL ACCESSORIES

10.1 OPTIONAL ACCESSORIES	16
---------------------------------	----

11. TROUBLESHOOTING

11.1 TROUBLESHOOTING	17-18
----------------------------	-------

12. MAINTENANCE

12.1 MAINTENANCE	19
------------------------	----

13. EXPLANATION OF SYMBOLS

13.1 EXPLANATION OF SYMBOLS.....	20-21
----------------------------------	-------

14. DISPOSAL

14.1 DISPOSAL	22
---------------------	----

DECLARATION OF CONFORMITY	ENCLOSED
---------------------------------	----------

3. WARRANTY

3.1 WARRANTY

Draper tools have been carefully tested and inspected before shipment and are guaranteed to be free from defective materials and workmanship.

Should the tool develop a fault, please return the complete tool to your nearest distributor or contact:

Draper Tools Limited, Chandler's Ford, Eastleigh, Hampshire, SO53 1YF. England.

Telephone Sales Desk: (023) 8049 4333 or:

Product Helpline (023) 8049 4344.

A proof of purchase must be provided.

If upon inspection it is found that the fault occurring is due to defective materials or workmanship, repairs will be carried out free of charge. This warranty period covering labour is 12 months from the date of purchase except where tools are hired out when the warranty period is 90 days from the date of purchase. The warranty is extended to 24 months from the date of purchase for parts only. This warranty does not apply to any consumable parts, any type of battery or normal wear and tear, nor does it cover any damage caused by misuse, careless or unsafe handling, alterations, accidents, or repairs attempted or made by any personnel other than the authorised Draper warranty repair agent.

Note: If the tool is found not to be within the terms of warranty, repairs and carriage charges will be quoted and made accordingly.

This warranty applies in lieu of any other warranty expressed or implied and variations of its terms are not authorised.

Your Draper warranty is not effective unless you can produce upon request a dated receipt or invoice to verify your proof of purchase within the warranty period.

Please note that this warranty is an additional benefit and does not affect your statutory rights.

Draper Tools Limited.

4. INTRODUCTION

4.1 SCOPE

This MMA -MIG welding converter can perform MIG welding in conjunction with a MMA inverter welder to weld ferrous metals such as steel and iron. Any other application is considered misuse.

4.2 SPECIFICATION

Stock no	00587
Part no	MCB200
Input:	
Working voltage	33V-85V DC
Rated welding current	200A
Output:	
Amperage.....	35-200A
Amperage range	20-200A
Duty cycle.....	60%@200A 100%@155A
Drive wire feed	0.6,0.8mm
Wire Speed.....	8m/min,16m/min
Wire feed motor power	16W
Control Voltage.....	DC 24V
Current Range	35A-200A (Dependant on MMA machine connected)
Wire Diameter(mm)	0.6-0.8mm
Wire sizes	0.6 and 0.8mm
Spool size	0.6kg (102mm diameter)
Gas or Gas-less modes.....	Gas and Gas-less modes
Degree of Protection	IP21S
Cooling	Air (Fan)
Dimensions (L x W x H).....	507x175x430mm
Weight (gross).....	4.22kg

4.3 HANDLING & STORAGE

- Care must be taken when handling this product.
 - Dropping this tool could have an effect on its accuracy and could also result in personal injury. This tool is not a toy and must be respected.
- Environmental conditions can have a detrimental effect on this product if neglected.
 - Exposure to damp air can gradually corrode components.
 - If the product is unprotected from dust and debris, components will become clogged.
 - If not cleaned and maintained correctly or regularly, the machine will not perform at its best.

5. HEALTH AND SAFETY INFORMATION

When using any type of power tool there are steps that should be taken to make sure that you, as the user, remain safe.

Common sense and a respect for the tool will help reduce the risk of injury.

5.1 GENERAL SAFETY INSTRUCTIONS FOR POWER TOOL USE

Warning!

- Read all safety warnings and all instructions. Failure to follow the warnings and instructions may result in electric shock, fire and/or serious injury.
- The term "power tool" in the warnings refers to your mains operated (corded) power tool or battery-operated (cordless) power tool.

Most important: You must know how to safely start and stop this machine, especially in an emergency.

Keep the work area tidy and clean. Attempting to clear clutter from around the machine during use will reduce your concentration. Mess on the floor creates a trip hazard. Any liquid spilled on the floor could result in you slipping.

Find a suitable location. If the machine is bench mounted, the location should provide good natural light or artificial lighting as a replacement. Avoid damp and dusty locations as it will have a negative effect on the machine's performance. If the machine is portable do not expose the tool to rain. In all cases do not operate power tools near any flammable materials.

Keep bystanders away. Children, onlookers and passers by must be restricted from entering the work area for their own protection. The barrier must extend a suitable distance from the tool user.

Unplug and house all power tools that are not in use. A power tool should never be left unattended while connected to the power supply. They must be housed in a suitable location, away locked up and from children.

Do not overload or misuse the tool. All tools are designed for a purpose and are limited to what they are capable of doing. Do not attempt to use a power tool (or adapt it in any way) for an application it is not designed for. Select a tool appropriate for the size of the job. Overloading a tool will result in tool failure and user injury. This covers the use of accessories.

Dress properly. Loose clothing, long hair and jewellery are all dangerous because they can become entangled in moving machinery. This can also result in parts of body being pulled into the machine. Clothing should be close fitted, with any long hair tied back and jewellery and neck ties removed. Footwear must be fully enclosed and have a non-slip sole.

Wear personal protective equipment (PPE). Dust, noise, vibration and swarf can all be dangerous if not suitably protected against. If the work involving the power tool creates dust or fumes wear a dust mask. Vibration to the hand, caused by operating some tools for longer periods must be protected against. Wear vibration reducing gloves and allow long breaks between uses. Protect against dust and swarf by wearing approved safety goggles or a face shield. These are some of the more common hazards and preventions, however, always find out what hazards are associated with the machine/work process and wear the most suitable protective equipment available.

Do not breathe contaminated air. If the work creates dust or fumes connect the machine (if possible) to an extraction system either locally or remotely. Working outdoors can also help if possible.

Move the machine as instructed. If the machine is hand held, do not carry it by the power supply cable. If the product is heavy, employ a second or third person to help move it safely or use a mechanical device. Always refer to the instructions for the correct method.

Do not overreach. Extending your body too far can result in a loss of balance and you falling. This could be from a height or onto a machine and will result in injury.

Maintain your tools correctly. A well maintained tool will do the job safely. Replace any damaged or missing parts immediately with original parts from the manufacturer. As applicable keep blades sharp, moving parts clean, oiled or greased, handles clean and emergency devices working.

5. HEALTH AND SAFETY INFORMATION

Wait for the machine to stop. Unless the machine is fitted with a safety brake, some parts may continue to move due to momentum. Wait for all parts to stop, then unplug it from the power supply before making any adjustments, carrying out maintenance operations or just finishing using the tool.

Remove and check setting tools. Some machinery requires the use of additional tools or keys to set, load or adjust the power tool. Before starting the power tool always check to make certain they have been removed and are safely away from the machine.

Prevent unintentional starting. Before plugging any machine in to the power supply, make sure the switch is in the OFF position. If the machine is portable, do not hold the machine near the switch and take care when putting the machine down, that nothing can operate the switch.

Carefully select an extension lead. Some machines are not suitable for use with extension leads. If the tool is designed for use outdoors, use an extension lead also suitable for that environment. When using an extended lead, select one capable of handling the current (amps) drawn by the machine in use. Fully extend the lead regardless of the distance between the power supply and the tool. Excess current (amps) and a coiled extension lead will both cause the cable to heat up and can result in fire.





Concentrate and stay alert. Distractions are likely to cause an accident. Never operate a power tool if you are under the influence of drugs (prescription or otherwise), including alcohol or if you are feeling tired. Being disorientated will result in an accident.

Have this tool repaired by a qualified person. This tool is designed to conform to the relevant international and local standards and as such should be maintained and repaired by someone qualified, using only original parts supplied by the manufacturer. This will ensure the tool remains safe to use.

CAUTION!

5.2 CONNECTION TO THE POWER SUPPLY

Make sure the power supply information on the machine's rating plate are compatible with the MMA machine you intend to connect it to.
(Maximum 200A MMA inverter machine).

DRAPER [®]		DRAPER TOOLS Ltd. Hursley Road, Chandlers Ford, Eastleigh, Hants SO53. 1YF. UK.		
MCB200		Serial No.		
		EN60974-1 EN60974-10		
	40A/16.0V - 200A/24V			
	X	30%	60%	100%
S U ₀ : 33-95V	I ₂	200A	155A	109A
	U ₂	24V	21V	19V
DC	U ₁ : 33-95V	I _{1max} = 200A		
IP21				



6. TECHNICAL DESCRIPTION

6.1 IDENTIFICATION

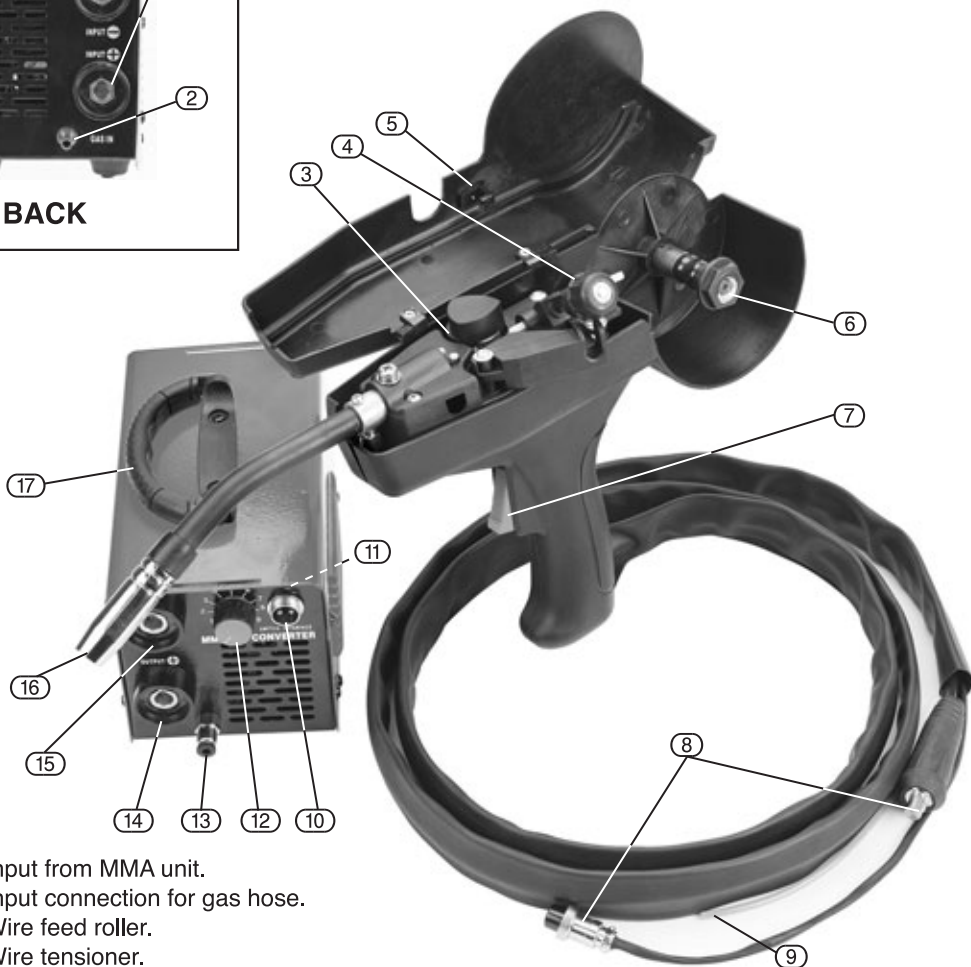
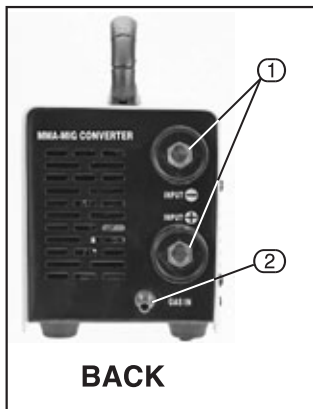

- ① Input from MMA unit.
- ② Input connection for gas hose.
- ③ Wire feed roller.
- ④ Wire tensioner.
- ⑤ Spool torch lid catch.
- ⑥ Spool hub.
- ⑦ Trigger.
- ⑧ MIG torch connectors.
- ⑨ Gas hose.
- ⑩ MIG torch connection.
- ⑪ Power indicator.
- ⑫ Wire feed speed adjuster.

- ⑬ Gas output connection.
- ⑭ “+” Output. *
- ⑮ “-” Output. *
- ⑯ Gas shroud.
- ⑰ Transport handle.

* For welding with solid core wire and gas connect torch to + connection. To use flux cored gasless wire connect torch to - connection.

7. UNPACKING AND CHECKING

7.1 PACKAGING

Carefully remove the machine from the packaging and examine it for any sign of damage that may have happened during shipping. Lay the contents out and check them against the parts shown below. If any part is damaged or missing; please contact the Draper Helpline (the telephone number appears on the Title page) and do not attempt to use the machine.

The packaging material should be retained at least during the guarantee period: in case the machine needs to be returned for repair.

Warning! Some of the packaging materials used may be harmful to children. Do not leave any of these materials in the reach of children.

If any of the packaging is to be thrown away, make sure they are disposed of correctly; according to local regulations.

7.2 WHAT'S IN THE BOX?

As well as the converter/spool gun; there are several parts not fitted or attached to it.



- (18) Connection cables.
- (19) Flux cored MIG wire

- (20) Coupling adapters.
- (21) Mild steel MIG wire.

8. PREPARING THE WELDER

8.1 OTHER TOOLS NEEDED IN CONJUNCTION WITH CONVERTER KIT

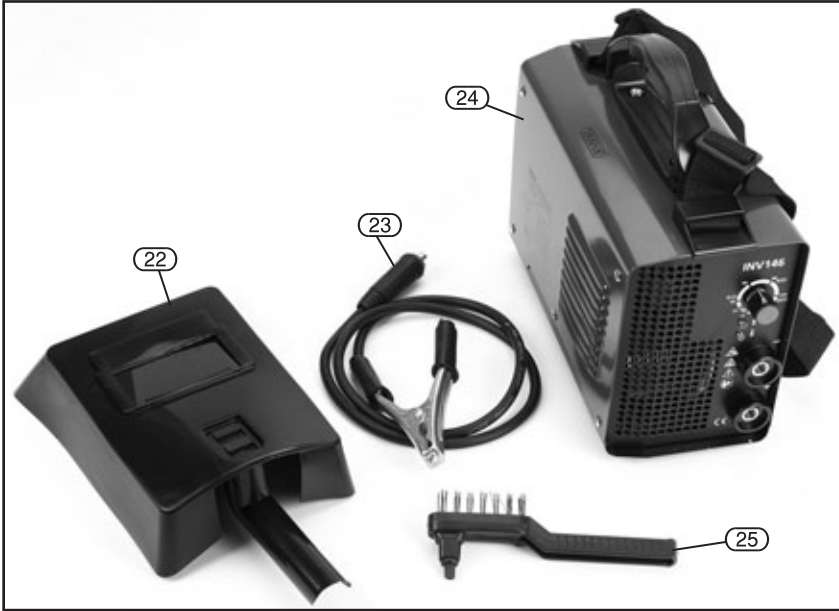

- (22) Face shield.
- (23) Earth clamp.

- (24) MMA inverter welder
(example Draper stock No.64533).
- (25) Chipping hammer/brush.

8.2 GENERAL

This medium weight, portable welder requires no special lifting instructions, however it contains dedicated circuitry and must be handled with care. The welder is designed to weld by means of a filler wire feed through the torch (MIG).

8.3 LOCATION

Locate the machine in close proximity to the correct power supply and allow 500mm air gap around to ensure sufficient ventilation. There is a cooling fan located in the machines housing which must be kept clear. Equally, ensure no debris can be drawn into the machine.

Make certain the location does not pose any hazards as detailed in the safety instructions, before attempting to start the machine.

NOTE: Refer to the rating label for energy input details.

Ensure the gas bottle is securely mounted and in a vertical position according to the manufacturer's instructions.

WARNING: Remove the plug from the socket before carrying out adjustment, servicing or maintenance.

8. PREPARING THE WELDER

8.4 INSTALLING THE FILLER WIRE - FIGS. 1 - 10

The welding machine is designed to accept the standard size drums of wire up to 0.6kg.

The welding wire can be either of the flux cored type this provides a means of shielding the weld pool from the atmosphere.

Or non flux wire with the gas hose connected to the converter.

Do not let the filler wire become uncoiled or tangled as this will lead to problems with delivery to the welding torch.

Select the filler wire suitable for the parent metal and with a gauge to match the welder specification.

Note: If the welding machine is not regularly used, remove the wire which is prone to rusting and will cause feed problems next time.

1. Slide the catch (5) to the right and lift up the cover.



FIG.1

2. Unscrew the tensioner (4) and lift to release the tension arm.



FIG.2

3. Note: The wire must sit in the appropriate groove that matches the wire gauge.

Twist cap (3.1) 90° anti-clockwise and lift. The groove size is etched on the side of the roller (0.6 or 0.8mm). Lift the wheel off the spindle and flip so the correct wire thickness is visible.

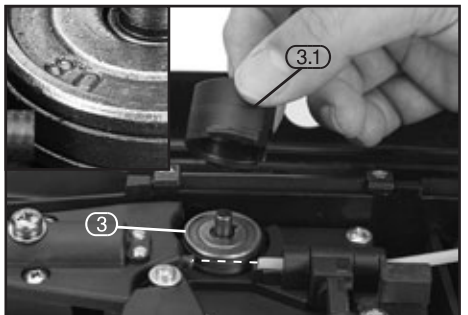

FIG.3

8. PREPARING THE WELDER

4. Unscrew the nut (6) (turning it anti-clockwise). Sit the reel on to the hub. Refit the nut.
5. Fit the wire spool so that it feeds off the top of the reel towards the wire drive unit.

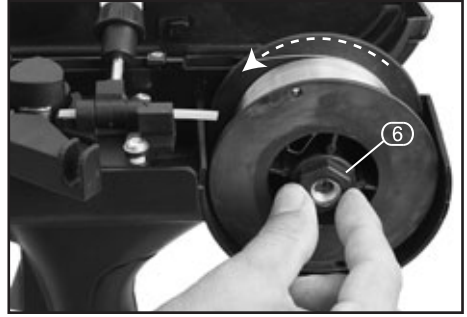

FIG.4

6. Feed wire into tube past the drive roller.

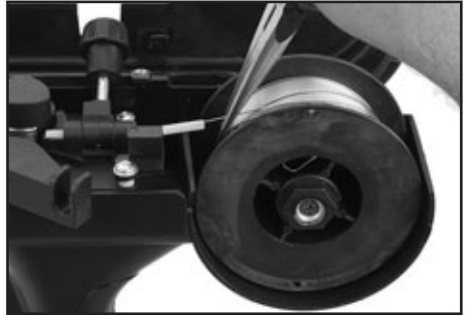

FIG.5

7. Push the tension arm (4.1) to pinch the wire in the wire groove, pull the tensioner (4) down to lock the tension arm in position.

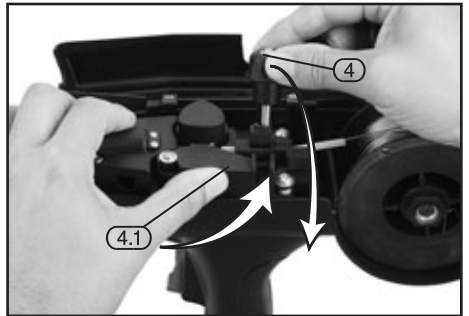

FIG.6

8. When the welder is connected to the power supply, press the trigger (7) to pull the wire through the rollers.

Note: Adjust the tensioner to vary the tension on the wire to keep the feed constant.

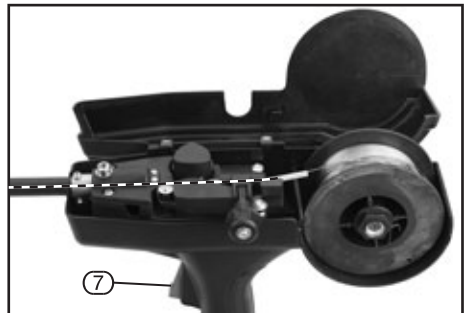

FIG.7

8. PREPARING THE WELDER

9. Remove the gas shroud (16) and with a small spanner unscrew and remove the tip (16.1). Press the feed trigger on gun and observe the wire feed mechanism. If the wire is being fed correctly it will come out of the swan neck. Pass the tip over the wire and secure back onto the swan neck. Do not over tighten. Re-secure the gas shroud and trim the wire back as required. Note: Ensure the tip size matches the wire size prior to installing.

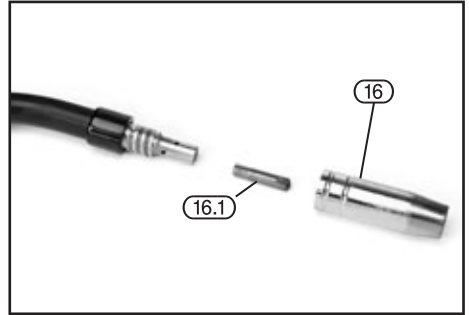

FIG.8

10. Connect the converter to a MMA welder as shown in Fig.9.

The image shows the spool gun connected for MIG welding using gas.

For no gas:

Turn gas off then disconnect the gas tubes (2) + (13).

Swap the earth clamp (23) and the spool gun (8) connections around.

Then change the spool for a flux cored MIG wire of the correct diameter.

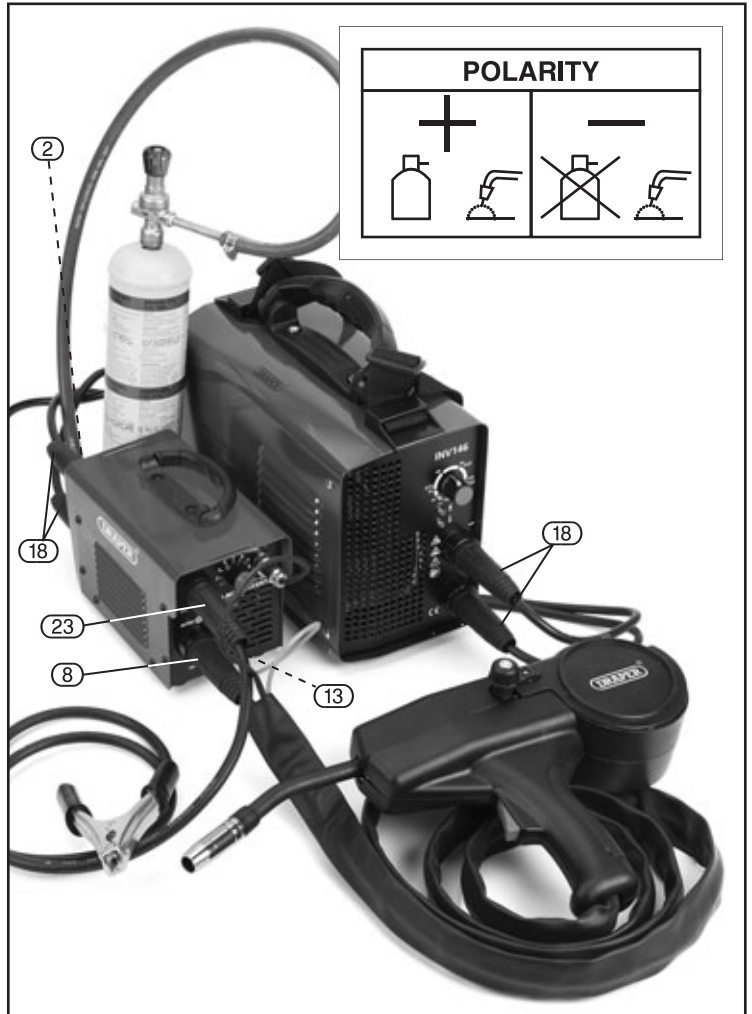

FIG.9

9. BASIC WELDING OPERATION

9.1 MIG WIRE SPEED ADJUSTMENT- FIG. 10

Wire speed is dependent on material thickness and welding current. Being able to judge the correct wire speed based on the sound and quality of the weld will only come from practice.

- Too fast will result in holes blowing in the weld or the wire hitting the metal will force the torch backward.
- Too slow will result in the wire burning back to the torch into a ball and clogging the tip.



FIG.10

9.2 MIG WELDING PRINCIPLES FIG. 11

The MIG welding process allows two similar materials to be fused together without altering the properties of the material. The electric arc created between the electrode (the welding wire) and the work piece produces the required heat for turning the metal into a molten state. The gas creates a shield around the arc and the molten metal.

The area to be welded and the earth point must be clean of grease, dirt, paint and rust. Clean with a wire brush as necessary. Position the earth clamp as close as possible to the working area and ensure a tight grip is achieved.

Select the welding current based on the thickness of the material. A thick piece will require a high current, however due to the duty cycle this will effect the welding time by significantly reducing it. A thin piece will only require minimal heat and so the current can be less. This will allow a longer period of welding. The position of the torch is critical to the arc and end results.

The position of the welding torch is important to achieve a good quality bead. Position the torch at approximately 35° vertically and 75° horizontally and up to 20mm* distance from the joint. 20mm is the maximum that can be achieved on the maximum setting. Ensure the gas shroud remains clean of spatter. Likewise and more importantly the wire feed tip must be kept clean to avoid the wire becoming blocked or restricted.

Use of an anti-spatter spray (Draper Stock No.05709) will help keep the end result more tidy.

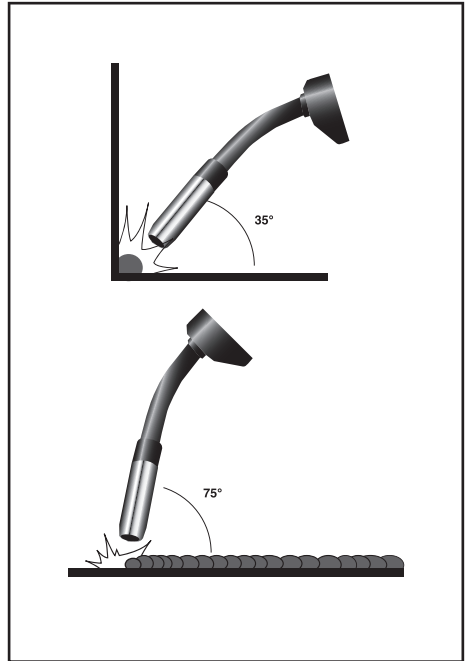

FIG.11

9. BASIC WELDING OPERATION

NOTE: Although this machine is light weight and portable take care with additional items i.e. gas bottles etc. Do not manoeuvre over people's heads.

Note: Welding is a mix of science and art and due to the complex principles and vast differences in parameters (ie. Material type, position, condition etc.) That information is well beyond the scope of this manual.

Draper Tools suggest training be obtained from a third party or refer to a suitable reference book on the subject additionally; nothing can beat practice using the welder on scrap material to get a better understanding.

9.3 DEFINITION:

DUTY CYCLE:

Duty Cycle is a percentage of 10 mins. in which a machine can operate at a rated load without overheating and interruption from the thermal cut-out device.

Example: 150A @ 30% Duty factor



150A welding for 3 minutes



7 minutes down time

Example: 95A @ 100% Duty factor



95A continuous welding

To increase the operation time, reduce the amperage.

NOTE: The heating tests have been carried out at ambient temperature and the duty cycle (duty factor) at 20°C has been determined by simulation

Definition:

METAL INERT-GAS (MIG welding)

Also known as GMAW (Gas metal arc welding)

A welding process in which an electric arc forms between a consumable wire electrode and the workpiece metal(s), which heats the workpiece metal(s), causing them to melt, and join. Along with the wire electrode, a shielding gas feeds through the welding gun, which shields the process from contaminants in the air.

9.4 THERMAL CUT-OUT INDICATOR

If welding for extended periods the thermal cut-out will activate on the parent machine (MMA inverter) prohibiting use of the machine until sufficiently cool. The thermal cut-out indicator will illuminate while the machine is disabled.

ATTENTION: After completion of any welding task leave the unit connected to the power supply for a sufficient period to allow the cooling fan to continue working.

10. OPTIONAL ACCESSORIES

10.1 OPTIONAL ACCESSORIES

Please contact your local Draper dealer for a current and complete list of accessories.

Stock No.	Part No.	Description
77175	WSIF556	0.6mm Mild steel MIG wire
77176	WSIF558	0.8mm Mild steel MIG wire
77174	WSIF512	0.8mm Stainless steel MIG wire
77180	WSIF0905	0.8mm Flux cored MIG wire

11. TROUBLESHOOTING





11.1 TROUBLESHOOTING

WARNING: For your own safety, turn the switch off and remove the plug from the power supply socket.

PROBLEM	POSSIBLE CAUSE	REQUIRED ACTION
<ul style="list-style-type: none">• Wire not feeding despite wire feed pulley turning.	<ul style="list-style-type: none">• Dirty current nozzle (torch tip).• Wire feed pulley set too tight.• Too low clamping pressure of the wire feed pulley.	<ul style="list-style-type: none">• Clean.• Loosen.• Increase the clamping pressure.
<ul style="list-style-type: none">• Interrupted or disruptive wire supply.	<ul style="list-style-type: none">• Damaged current nozzle.• Burnt current nozzle.• Dirty driving gear nozzle.• Cut on worn driving gear.	<ul style="list-style-type: none">• Replace.• Replace.• Clean.• Replace.
<ul style="list-style-type: none">• Electric arc turned off.	<ul style="list-style-type: none">• Poor contact between earth clamp and part to be welded• Short circuit between current nozzle and gas supply pipe.• Too loose current nozzle.	<ul style="list-style-type: none">• Tighten the pliers and check them, remove paint and rust.• Clean or replace the current and gas nozzle, remove dirt, paint and rust.• Tighten the current nozzle firmly.
<ul style="list-style-type: none">• Porous welded joint.	<ul style="list-style-type: none">• No gas, too little gas or wrong gas.	<ul style="list-style-type: none">• Secure or replace the gas supply (higher volume).
<ul style="list-style-type: none">• Welder suddenly stops working after longer operation.	<ul style="list-style-type: none">• Welder has overheated due to too long use and the thermal protection has activated.	<ul style="list-style-type: none">• Let the welder cool down.

IMPORTANT: Please note all repairs/service should be carried out by a qualified person.

11. TROUBLESHOOTING

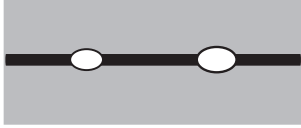
Example	Term	Cause
	Insufficient penetration	<ul style="list-style-type: none"> - Incorrect arc distance - Welding current too low - Wire speed too low - Welding line not central to butt
	Overlap	<ul style="list-style-type: none"> - Wire size too large for application - Torch speed too slow
	Pitting	<ul style="list-style-type: none"> - Contamination in the metal (eg rust) - Flux shield breakdown - Incorrect arc distance - Area cooling down too fast
	Untidy weld	<ul style="list-style-type: none"> - Unsteady torch movement - Worn wire tip
	Burn through	<ul style="list-style-type: none"> - Current too high for material thickness - Torch speed too slow

12. MAINTENANCE

12.1 MAINTENANCE

Warning: Remove the plug from the power supply. Periodically the welder must be checked as detailed below.

- Check the torch cable and ground cable connections.
- Clean the contact tip and the gas shroud with an iron brush. Replace if worn.
- Clean the outside of the welder with a damp cloth.
- Every time the wire spool is replaced:
 - Check the alignment, cleanliness and state of wear of the wire roll.
 - Remove any metal powder deposited on the wire feeder mechanism and then dry with compressed air.
- Occasionally test to ensure the thermal cut-out device is operating correctly, i.e. weld for an extended period or on a maximum duty cycle.
- Check the condition of the warning labels.
- Replace any worn parts.
- If the replacement of the supply cord is necessary, this has to be done by the manufacturer or his agent in order to avoid a safety hazard.

13. EXPLANATION OF SYMBOLS

13.1 EXPLANATION OF SYMBOLS



Wear personal protective equipment.



Single-phase alternating current with rated frequency of 50Hz.



Welding mask to be used!



Protect against humidity.



Special welding gloves to be worn at all times.



This side up.



Wear safety cut through resistant shoes with safety sole and steel toe!



Caution - hot surface!



Protective apron to be used.



Warning against toxic fumes! Not to be used in enclosed spaces.



Before carrying out any work on the machine, disconnect the plug from the socket.



Protect against humidity. Never expose tool to rain.



Pressure bottle to be secured by chain.



Prohibition for persons with a pacemaker!



Warning against dangerous voltage.



Keep bystanders away.



Risk of explosion.

13. EXPLANATION OF SYMBOLS

Letter Symbols:

X	Duty Cycle
I_1	Rated Supply Current
U_1	Rated Supply Voltage
I_2	Conventional Welding Current
U_2	Conventional Welding Voltage

Pictogram Symbols:



Transformer.†



Direct Current (DC) delivery.†



Inverter†
Frequency conversion stage.

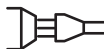

Power supply identifier
e.g. socket outlet with 3 poles.

† Symbols can be combined
for example:



Single Phase Static Frequency
Converter/Transformer Rectifier.



Semiconductor diode rectifier.†



Read instruction manuals before
operating and servicing this
equipment.



Warning.



WEEE
Do not dispose of Waste
Electrical & Electronic
Equipment in with domestic rubbish
* Waste Electrical & Electronic Equipment.



Suitable for welding operations in
hazardous situations. No-load
voltage below 48V rms AC or
113V peak DC.



MIG welding (Metal Inert Gas) or
GMAW (Gas Metal Arc Welding)

14. DISPOSAL

14.1 DISPOSAL

- At the end of the machine's working life, or when it can no longer be repaired, ensure that it is disposed of according to national regulations.
- Contact your local authority for details of collection schemes in your area.

In all circumstances:

- Do not dispose of power tools with domestic waste.
- Do not incinerate.
- Do not abandon in the environment.
- Do not dispose of WEEE* as unsorted municipal waste.



■
* Waste Electrical & Electronic Equipment.

CONTACTS

Draper Tools Limited, Hursley Road,
Chandler's Ford, Eastleigh, Hampshire. SO53 1YF. U.K.

Helpline: (023) 8049 4344

Sales Desk: (023) 8049 4333

Internet: drapertools.com

E-mail: sales@drapertools.com

General Enquiries: (023) 8026 6355

Service/Warranty Repair Agent:

For aftersales servicing or warranty repairs, please contact the
Draper Tools Helpline for details of an agent in your local area.

YOUR DRAPER STOCKIST

KCMC0818

©Published by Draper Tools Limited.

No part of this publication may be reproduced, stored in a retrieval system or transmitted in any form or by any means, electronic, mechanical photocopying, recording or otherwise without prior permission in writing from Draper Tools Ltd.