

# Q Garden

## INSTRUCTION MANUAL

# 500W Electric Hedge Trimmer

Model No: QG500ERLT  
Product No: 1938287001

ASSEMBLY REQUIRED  
SAVE THESE INSTRUCTIONS

Please read & understand this manual, paying attention to the safety instructions, before use.

Incorrect use of the product could put the operator or machine in danger.

Whilst every effort has been made to ensure the accuracy of information contained in this manual, our policy of continuous improvement determines the right to make modifications without prior warning.

Images used are for illustration purposes only.

### *Copyright Notice*

Copyright © Handy Distribution

Permission is granted to reproduce this publication for personal & educational use only.

Commercial copying, redistribution, hiring or lending is prohibited.

No part of this publication may be stored in a retrieval system or transmitted in any other form or means without written permission from Handy Distribution.

In all cases this copyright notice must remain intact.

## CONTENTS

SPECIFICATION  
IMPORTANT INFORMATION  
GENERAL SAFETY INSTRUCTIONS  
KNOW YOUR MACHINE  
ASSEMBLY  
OPERATION  
MAINTENANCE & STORAGE  
TROUBLE SHOOTING  
PARTS DIAGRAM & LIST  
DECLARATION OF CONFORMITY  
WARRANTY

If you require any assistance with regards to the contents or operation of your machine, please call the Studio Customer Service phone number 0371 200 0378.  
(Lines are open 8am - 8pm Monday to Friday & 9am to 5pm Weekends.)

## SPECIFICATION

The manufacturer reserves the right to change the product specification and livery according to continued product improvements.

Model	QG500ERHT
Product Number	1938287001
Voltage	220-240V, 50Hz
Power	500W
No Load Speed	3300 rpm
Cutting Length	560 mm
Cutting Diameter	16 mm
Guaranteed Noise Power Level (L <sub>WA</sub> )	103 dB(A)
Vibration (a <sub>nv</sub> )	2.61 m/s <sup>2</sup> - uncertainty K: 1.5 m/s <sup>2</sup>
Net Weight	3.7 kg

Consistent with our policy of continuous improvement, QGARDEN reserves the right to change the design and configuration of any of its products without notice or obligation. Therefore, please treat the text and images in this manual as being for illustrative purposes only. They may in no case serve as a basis for any legal claim.

If you require assistance with regards to the contents or operation of the machine, please contact us:

Tel: 01793 333212

Email: [customerservice@handydistribution.co.uk](mailto:customerservice@handydistribution.co.uk)

Opening hours weekdays:

February to October 8:30am - 5:30pm

November to January 8:30am - 5:00pm

(Closed Bank Holidays)

## IMPORTANT INFORMATION



### WARNING

Read this instruction manual carefully before operating this machine. Make sure that you are familiar with the controls and properly operate the machine. Following these instructions can reduce the risk of fire, electric shock and personal injury.

### IF NOT USED PROPERLY THIS MACHINE CAN BE DANGEROUS!

This machine can cause serious injury to the operator and others, the warning and safety instructions must be followed to ensure reasonable safety and efficiency in using this product. The operator is responsible for following the warning and safety instructions in this manual and on the machine. Never use the product unless the grass box or guards are correctly positioned.

### DESIGNED FOR DOMESTIC USE ONLY.

This machine is to be used exclusively for trimming light foliage from bushes and hedges of domestic gardens. Never use the line trimmer for other purposes. Any other use can endanger your safety and can involve damage to the line trimmer. Persons under 16 years of age and persons who are not familiar with the user instructions must not use the machine. The user is responsible for the safety of other people in the working area. Keep children and domestic animals at a safe distance while the line trimmer is in use. Before using, remove all foreign objects from the lawn edges which may be thrown by the machine, stay alert for any foreign objects which may have been missed. These operating instructions must be kept and referred to in order to ensure that the equipment is properly used and maintained. The instructions contain valuable information on operating, maintenance and servicing conditions.

### TRAINING

Read the instructions carefully: Be familiar with the controls and the proper use of the equipment.

Never allow children or people unfamiliar with these instructions to use the product. Local regulations can restrict the age of the operator.

Never operate while people, especially children, or pets are nearby.

Keep in mind that the operator or user is responsible for accidents or hazards involving the machine that occur to other people or their property.



### WARNING

The equipment is to be used only for its prescribed purpose. Any other use is deemed to be a case of misuse.

















The user/operator and not the manufacturer will be liable for any damage or injuries of any kind caused as a result of this.

Please note that our equipment has not been designed for use in commercial, trade or industrial applications.

Our warranty will be 90 days from the original date of sale for commercial, trade or industrial businesses or for equivalent purposes.

## GENERAL SAFETY INSTRUCTIONS

It is important that you read and understand the owner's manual and labels affixed to the machine. Learn its application and limitations as well as the specific potential hazards. Retain these instructions for future reference. The operator is responsible for following the warnings & instructions in this manual and on the product.

	Read & understand operator's manual before using the machine. Failure to follow instructions could result in death or serious injury. Please keep in a safe place for future reference.		Always wear eye and ear protection
	Keep all bystanders & animals away from the machine during operation. If approached, stop the machine immediately.		SHARP BLADES Always wear gloves to protect your hands.
	Before working or undertaking any servicing or cleaning of the machine, ensure the electrical cable is removed from the power source.		Wear foot protection or sensible shoes when using the machine
	WARNING Remove the plug from the power source immediately if the cable is damaged or cut.		Do not expose to rain or damp conditions.
	Keep guards in place and in working order. Replace damaged, missing or failed parts before using it.		Moving parts can contact or entangle hands, feet, hair, clothing or accessories. Traumatic amputation or severe laceration can result
	Class II Protection		Safety alert symbol. Used to alert you to potential personal injury hazards. Obey all safety messages that follow this symbol to avoid possible injury.
 DANGER	Indicates an imminently hazardous situation which, if not avoided, will result in serious injury	 WARNING	Indicates a potentially hazardous situation which, if not avoided, could result in serious injury
 CAUTION	Indicates a potentially hazardous situation which, if not avoided, may result in minor or moderate injury.	CAUTION	Used without the safety alert symbol indicates a potentially hazardous situation which, if not avoided, may result in property damage.
	CE Marking - the product meets demand and regulations set by the EU		Noise Level - See label on machine



According to the European directive 2012/19/EU for Waste Electrical and Electronic Equipment and its implementation into national law, electrical and electronic equipment that are no longer usable must be collected separately and disposed of in an environmentally correct manner.



## GENERAL SAFETY RULES



Before you put the machine into operation, you must read this instruction manual. When using this machine, observe the following safety instructions to exclude the risk of personal injury or material damage. Please also observe the special safety instructions in the respective chapters. Where applicable, follow the legal directives or regulations for the prevention of accidents in relation to the use of this machine.



### WARNING

When using electric tools, basic safety precautions, should always be followed to reduce the risk of serious personal injury and/or damage to the unit.



### DANGER

Danger from contact with live parts!  
Immediately disconnect the plug from the mains if the extension lead is damaged or severed!

## TRAINING



The operator must receive proper training in the use, adjustment and operation of the machine, including prohibited operations.

1. Read the instructions carefully. Be familiar with the controls & proper use of the equipment. Spend time to familiarise yourself with your machine before each use.
2. Never allow children or people unfamiliar with these instructions to use the machine. Local regulations can restrict the operator age.
3. This machine is not intended for use by persons (including children) with reduced physical, sensory or mental capabilities, or lack of experience and knowledge, unless they have been given supervision or instruction concerning use of the machine by a person responsible for their safety.
4. Never work while people, especially children, or pets are nearby.
5. The operator or user is responsible for accidents or hazards occurring to other people or their property.

## ELECTRIC SAFETY

1. The domestic mains voltage must match the mains voltage specifications in the technical data; do not use any other supply voltage.
2. The fuse must be a residual current circuit- breaker with a measured residual current of no more than 30 mA.
3. Ensure any extension leads used with this product, meets the minimum requirements of the machine and is suitable for outside use.
4. Damaged or brittle machine cables or extension leads must not be used.
5. Always check the condition of your cable or extension lead before operating the machine.
6. Always keep cable & extension lead out of the cutting area and routed away from the machine.
7. Never run over the cable or extension lead with the line trimmer.
8. Protect the machine against moisture.

## SAFETY INSTRUCTIONS FOR WORKING WITH YOUR HEDGE TRIMMER

1. Operate in daylight or good artificial lighting. If possible, do not use on overly wet ground.
2. Ensure good stability on slopes.
3. Be particularly careful if changing direction of travel on the slope.
4. Do not operate on steep slopes.
5. Operate whilst walking, do not run.
6. Be particularly careful when you turn or when you pull the machine towards you.
7. Stop the motor and blade, if it is to travel across other areas or must be transferred to/from working area.
8. Never use the machine with damaged safety protection guards.
9. Do not change the motor regulation set up.
10. Carefully start the motor. Keep your feet clear of the blade.
11. Never lift or carry the machine other than when in operation mode, while the motor is on.
12. Switch the motor off and remove electrical plug from the power source, before unblocking or removing obstacles from the blade or guard:
  - Before releasing blockages, inspecting, cleaning or working on the machine.
  - After hitting an obstruction. Search for damage on the machine & make repairs as necessary. If the machine starts vibrating unusually, it should be inspected by an Approved Service Dealer.

## WORK AREA

1. Keep work area clean and well lit. Cluttered and dark areas invite accidents.
2. Check the landscape where the machine will be used and remove all objects such as stones, toys, sticks and wires, which could be caught and thrown away from the work area. **Damage of the machine or operator's injury could be caused.**
3. Do not operate this machine in explosive atmospheres, in the presence of flammable liquids, gases or dust. Machines create sparks which may ignite the dust or fumes.
4. Keep children & bystanders away while operating the machine. Distractions can cause you to lose control.

## PERSONAL SAFETY

1. This machine is not intended for use by persons (including children) with reduced physical, sensory or mental capabilities, or lack of experience and knowledge, unless they have been given supervision or instruction concerning use of the machine by a person responsible for their safety.
2. Children should be supervised to ensure that they do not use or play with the machine.
3. Stay alert, watch what you are doing, use common sense when operating the machine.
4. Do not use this machine while you are tired, ill or under the influence of drugs, alcohol, or medication. A moment of inattention while operating this machine can cause you to lose control & may result in serious personal injury.
5. Do not overreach. Always keep proper footing and balance. This enables better control of the tool in unexpected situations.
6. Remove any adjusting tools before turning the machine on. A tool that is left attached to a rotating part of the machine may result in personal injury.
7. Use safety equipment. Always wear eye protection. Safety equipment such as a dust mask, non-skid safety shoes, hard hat, or hearing protection used for appropriate condition will reduce personal injuries.
8. Dress properly. Do not wear loose clothing or jewellery. Keep your hair, clothing & gloves away from moving parts. Loose clothes, jewellery or long hair can be caught in moving parts. Wear foot protection or sensible shoes when using the machine.
9. Prolonged use of the machine may lead to disorders of blood circulation in hands caused by vibration. These effects can be worsened by low ambient temperatures and/or by gripping the handgrips excessively tightly. Period of use you can extend with appropriate gloves or regular breaks. Take frequent work breaks. Limit the amount of exposure per day.

10. Do not force the machine. Use the correct machine for your application. The correct machine will do the job better and safer at the rate for which it was designed.
11. Do not use the machine if the trigger levers do not work to turn the machine off. Any machine that cannot be controlled with the trigger levers is dangerous and must be repaired.
  1. Turn machine off completely and the electrical plug removed from the power source before making any adjustments, changing accessories, or storing. Such preventive safety measures reduce the risks of starting the machine accidentally.
  2. Store idle machines out of the reach of children and do not allow persons unfamiliar with the machine or these instructions to operate. Electric machines are dangerous in the hands of untrained users.
  3. Maintain your machine. Check for misalignment or binding of moving parts, breakage of parts & any other condition that may affect the operation. If damaged, have the machine repaired by an Approved Service Dealer immediately. Many accidents are caused by poorly maintained machines.
  4. Use the machine, accessories and tool bits etc., in accordance with these instructions and in the manner intended for the particular type of electric machine, taking into account the working conditions and the work to be performed. Use of the machine for operations different from intended could result in a hazardous situation.

#### PERSON PROTECTION

1. In case of any injury, always proceed in accordance with the principles of first aid.
2. If someone is cut, cover the wound with a clean cloth & press hard to stop the flow of blood.
3. Individuals with poor circulation who are exposed to excessive vibration may experience injury to blood vessels or the nervous system. Vibration may cause the following symptoms to occur in the fingers, hands or wrists: numbness, tingling, pain, stabbing sensation, alteration of skin colour or of the skin. If any of these symptoms occur, see a doctor.

Put safety first in the case of fire:

4. If fire comes from the motor appears, at first distance yourself from the product to ensure your physical safety.
5. Use a dry powder fire extinguisher on the fire to prevent it from spreading.
6. A panicked reaction could result in the fire and other damage becoming more extensive.



## KNOW YOUR MACHINE

1. On / Off Trigger	2. Front Handle & Safety Trigger
3. Hand Guard	4. Cutting Blade
5. Blade Guard	

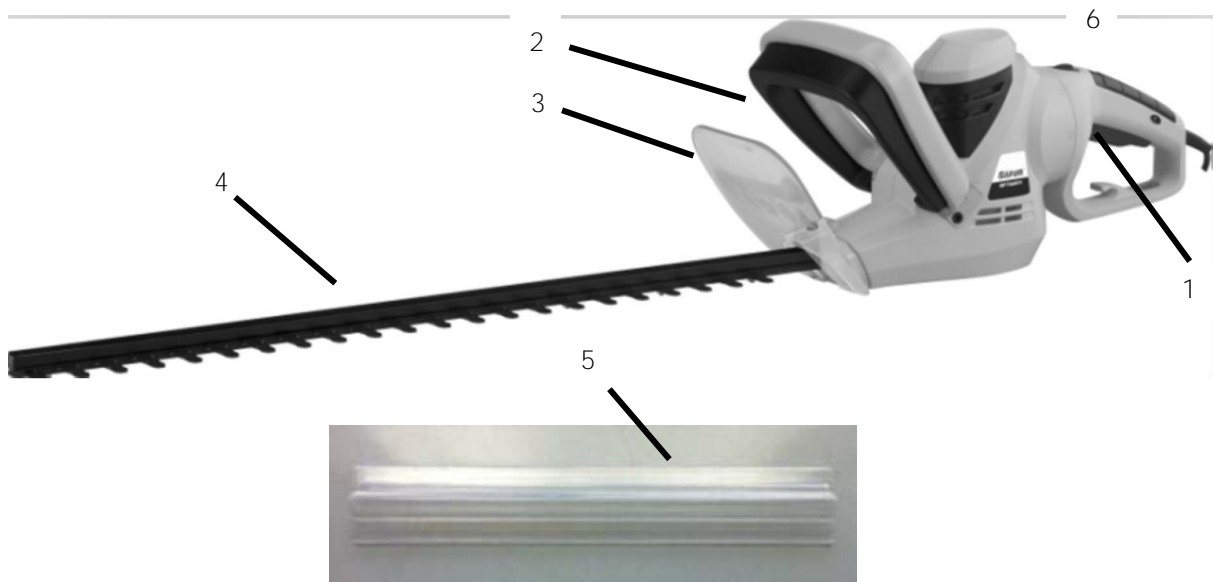

## ASSEMBLY



### WARNING

Stop the motor and unplug the electrical cable before any repairs or maintenance operations.

DO NOT attempt to start this machine without it first being FULLY assembled.

Your line trimmer has been supplied unassembled. Please follow the below steps to complete assembly.

### FRONT HANDLE

1. Put the hedge trimmer on the level surface. Grip the front handle (2) and slide it into the slot on both sides of the trimmer. (See Fig 1)
2. Fix the Front Handle (2) tightly with the two screws supplied. (See Fig 2)

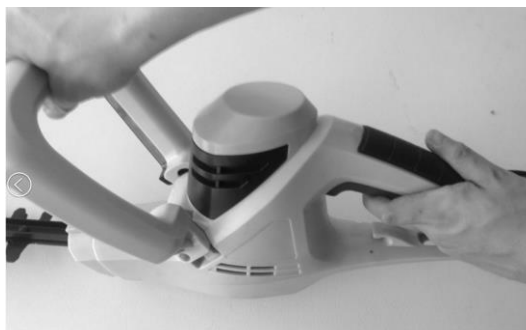

FIG 1



FIG 2

### PROTECTIVE GUARD

1. Slide the hand guard (3) into the slots at the end of the housing. (See Fig 3)
2. Fix the hand guard (3) with the supplied screw tightly. (See Fig 4)



FIG 3

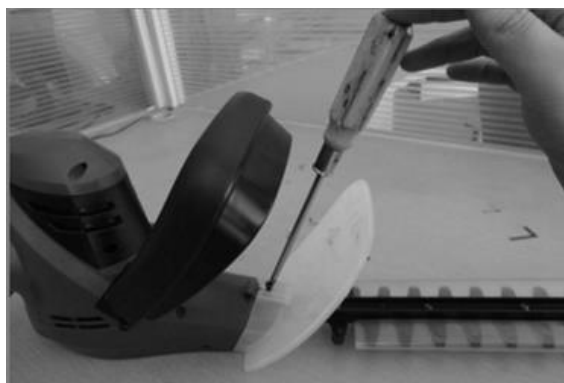

FIG 4

## OPERATION



### DANGER

Risk of injury! The device may only be put into operation if there are no defects. If a part is defective it must be replaced before the device is used again.



### WARNING

Risk of injury! Before starting work, check the area & remove all objects which may be kicked up by the unit.

### TURNING ON AND OFF

To prevent the tool accidental starting, this hedge trimmer is designed with a two hand safety switch.

To turn the hedge trimmer on, both the rear handle on/off trigger (1) and front handle safety switch (2) are required to be activated to start the hedge trimmer.

To turn the hedge trimmer off, release either the rear handle on/off trigger (1) or front handle safety switch (2).

### CORRECT OPERATING POSITION

Hold the unit with the left hand on the front handle, and the right hand on the rear handle. See image below:



#### BLADE BRAKE

- The hedge trimmer is fitted with an electric brake which very quickly brings the blades to a stop as soon as either the rear handle on/off trigger (1) or front handle on/off safety switch (2) are released.
- This safety feature reduces the chance of injury to the operator if a hand slips off the front or rear handle and control is lost temporarily.
- When the unit is switched off and the motor brake operates there may be some sparking (or flashing) in the area of the upper motor ventilation slots. This is perfectly normal and does not indicate a fault.

#### WORKING POSITION ADJUSTMENT

- Maintain proper footing and balance and do not overreach.
- Please wear safety goggles, nonslip footwear and rubber gloves when trimming. Hold the tool firmly in both hands and turn the tool on by squeezing both switches.
- Always hold the trimmer with one hand on the front handle (1) and the other on the rear handle (2).
- Never hold the tool by the safety guard (3).

#### TRIMMING NEW GROWTH

- The most effective way to trim new growth is to use a wide sweeping motion, feeding the blade teeth through the twigs.
- A slight downward tilt of the blade, in the direction of motion gives the best cut. Do not use the trimmer for cutting stems greater than 15mm in diameter. Use the trimmer only for cutting normal shrubbery found around houses and buildings.

#### LEVELING HEDGES

- Stretch a piece of string along the length of the hedge as a guide when leveling hedges.

#### SIDE-TRIMMING HEDGES

- Begin at the bottom and cut in an upward sweeping action so that the debris falls away from the trimmer and does not build up around the dual action cutting blades (4).

#### SHAPING

- A hedge should be trimmed to a trapezoidal form, that is, it should widen toward the bottom at both sides. This improves the penetration of light to the lower extremities. A general guideline is approximately a 10cm slant for each 1metre of hedge height.

#### CUTTING SEQUENCE

- First cut both sides, starting at the bottom and work to the top to prevent cuttings from falling into the area where you are still working.

#### TRIMMING THE TOP

- Where the branches have grown extremely long, cut back the hedge in several stages. The shorter the cuttings the better suited they are for composting.

#### GENERAL INFORMATION

- When older hedges are to be cut back a substantial amount, use pruning shears or some other device to trim thicker branches (greater than 15mm diameter) to the desired length before starting work with the hedge trimmer.
- To shape precisely, run a taught line between the extreme edges of the hedge and then trim along the length of the line.
- Ensure the dual action cutting blades (4) do not come into contact with any object made of hard material that could damage the blades, such as fencing wire or metallic plant supports.
- When the task is complete, turn off the tool, slip on the blade cover (5).

## TRIMMING INSTRUCTIONS

1. Walk, never run with the machine, be very careful when trimming uneven/rough ground.
2. Be careful when changing the direction of the trimmer on a slope.
3. Do not trim excessively steep slopes.
4. Best results will be achieved if the foliage is dry. Wet foliage will clog the blades.
5. Check that all nuts, bolts and screws are well tightened.
6. Work only when there is enough light.
7. Turn off the motor and remove the electrical plug from the power source, if you must leave the hedge trimmer unattended.
8. Never place your hands and feet between the blades while the motor is running.
9. Never change in any way the rated speed of the motor.
10. Never lift or carry the hedge trimmer above working height, while the motor is running.
11. Stop the motor and remove the electrical cable from the power source in these cases:
  - Before any operation under the guard.
  - Before any maintenance, repairing or checking operations.
  - Before carrying, lifting or removing the line trimmer.
  - If you leave the line trimmer unattended or changing the cutting height.
  - After hitting a foreign object, stop the hedge trimmer and check thoroughly the machine in order to see if it is damaged. Take the machine to a local Approved Service Dealer for inspection if necessary. Repairs of this nature are not covered **under the Manufacturer's warranty.**
  - If the hedge trimmer vibrates in an abnormal way, find the reasons why, and take your hedge trimmer to a local Approved Service Dealer.



### CAUTION

Allowing anyone to operate this machine without proper instruction may result in injury. Wear sturdy, full coverage footwear. Operating this machine with bare feet, or with open toe shoes or sandals increases your risk of injury.

Do not use the machine at night or in poor light.

Be sure to transport the machine from one place to another with the motor off. To prevent damage, check the machine for any signs of damage or other faults when operated.

## MAINTENANCE & STORAGE



### WARNING

Improper maintenance & storage of the machine may void your warranty.  
Keep the machine clean for better and safer performance.  
Turn off the motor and remove the electrical plug from the power source before performing any maintenance.

### MAINTENANCE

Use only original equipment replacement parts. Other parts may not perform as well, may damage the unit and may result in injury. In addition, use of other parts may invalidate your warranty.

- Before each use, check all nuts & bolts to be sure they are sufficiently tightened.
- We recommend only manufacturer original parts are used when maintaining this machine. Failure to do so could invalidate your manufacturer's warranty.
- The motor must be switched off and the electrical plug removed from the power source, before the machine is unassembled, cleaned, serviced or maintained.

### CLEANING



### CAUTION

Do not use a water hose or pressure washer to clean the machine. Water can damage the motor.

- Keep your machine clean. Thoroughly clean the machine at the end of each use.
- Clean the motor air vents with a cloth or brush. Motor air vents should be free from debris to allow air circulation around the motor during use.
- Clean the blade rail.

### STORING THE LINE TRIMMER

- Always unplug the machine from the mains for storage.
- For trouble free service, make sure the machine is clean and dry before storing.
- Please ensure the machine is stored away from direct sunlight.
- Store indoors or in a safe, locked protected area during severe weather and winter months.
- If storing for an extended period, inspect, clean and repair the machine if necessary. Store in a clean, dry, dust free area.
- Ensure the machine is stored in a position, where any persons cannot step on to attempt to reach items up high, due to risk of movement.
- The blades should be treated with light machine oil or spray lubricant after each use. The lubrication will also help prevent corrosion of the blade when not in use. When a job lasts for a longer period of time it is recommended that the blade rail also be treated with spray lubricant at regular intervals during operation.

### TRANSPORT

- Always unplug the machine from the mains for storage.
- Use the original packaging to ship whenever possible.

## TROUBLE SHOOTING



WARNING!

Only perform the steps described in these instructions!  
All further inspection, maintenance and repair work must be performed by an authorised service specialist!  
Contact your local authorised service dealer if the problem cannot be solved by yourself!



WARNING!

If the product does not perform properly, makes unusual sounds, the motor does not start or stop as described, the cutting device does not work properly, or any other irregularity or malfunction occurs, do not attempt to repair the product by yourself.

PROBLEM	POSSIBLE CAUSES	REMEDIAL ACTION
Motor does not start	No power supply	Check fuse / extension lead.
	Machine cable defective	Contact Approved Service Dealer.
	Cable has been cut through	Take machine to Approved Service Dealer for a non Warranty repair.

# PARTS DIAGRAM & LIST

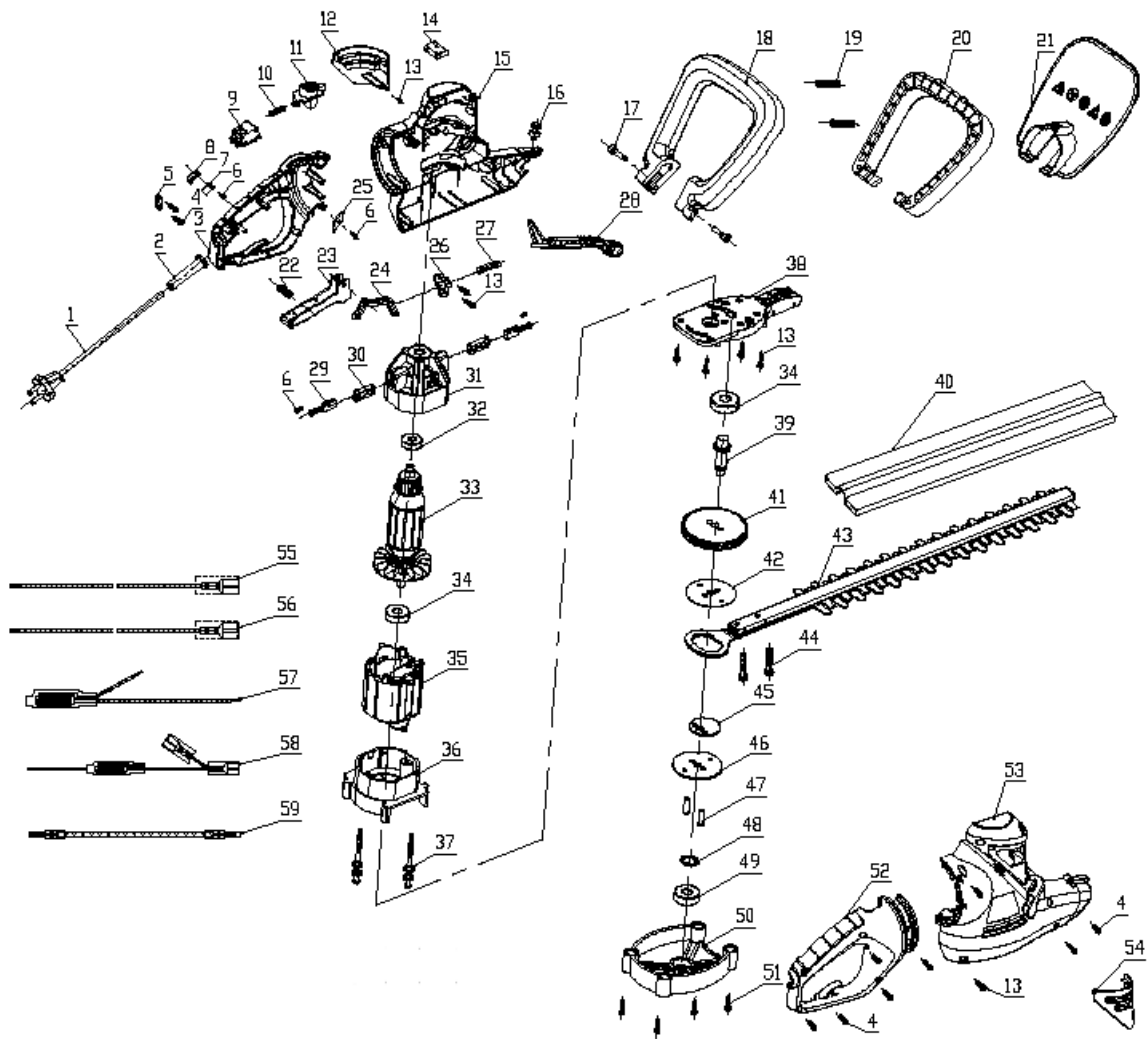

Item No	Part No.	Description	Qty
1	QG129-171-7A60101	Power Cable & Plug	1
2	QG129-196-7A10101	Cable Sheath	1
3	QG129-297-7A60101	Left Rear Casing	1
4	QG129-131-ABAD40-1005	Screw ST4x10	4
5	QG129-220-7A60201	Press Plate	1
6	QG129-131-ABCD30-0802	Screw ST3x8	1
7	QG129-147-7A60101	LED Light	1
8	QG129-314-7A60101	LED Cover	1
9	QG129-139-7A60101	Switch	1
10	QG129-344-7A60101	Spring	1
11	QG129-293-7A60101	Button	1
12	QG129-313-7A60201	Left Motor Cover	1
13	QG129-131-NBCD30-0801	Screw ST3x8	5
14	QG129-141-7J10301	Capacitor	1
15	QG129-303-7A60101	Left Front Casing	1
	QG129-132-8A60101	Screw M6x8	1
16	QG129-324-8A60102	Nut M5	1
17	QG129-131-AFDD06-1601	Screw M6x16	2



18	QG129-297-7A60201	Front Handle	1
19	QG129-344-7A60202	Front Handle Spring 2	2
20	QG129-296-7A60201	Front Safety Trigger	1
21	QG129-317-7A60201	Guard	1
22	QG129-344-7A60201	Trigger Spring 1	1
23	QG129-296-7A60101	Rear trigger	1
24	QG129-233-7A60103	Pull Rod	1
25	QG129-220-7A60101	Press Plate	1
26	QG129-249-7A60101	Fixed Base	1
27	QG129-235-7A60101	Push Rod	1
28	QG129-231-7A60102	Rotating Rod	1
29	QG129-118-7A60201	Carbon Brush	2
30	QG129-120-7A60201	Brush Holder	2
31	QG129-287-7A60201	Front Holder	1
32	QG129-369-A00060704	Bearing 607	1
33	QG129-115-7A60201	Rotor	1
34	QG129-369-A00060803	Bearing 608	2
35	QG129-117-7A60201	Stator	1
36	QG129-287-7A60202	Rear Holder	1
37	QG129-131-ABGD40-6001	Bolt	2
38	QG129-209-7A60201	Gear Case	1
39	QG129-334-7A60101	Output Shaft	1
40	QG129-196-7A60201	Blade Cover	1
41	QG129-359-7A60101	Large Gear	1
42	QG129-224-7A60101	Subplate 1	1
43	QG129-324-7A60201	Blade	1
44	QG129-44	Bolt M5	2
45	QG129-361-7A60101	Reciprocator	1
46	QG129-224-7A60102	Subplate 2	1
47	QG129-232-7A60101	Pin	2
48	QG129-130-G0801	Shaft Ring	1
49	QG129-369-A00060603	Bearing 606	1
50	QG129-209-7A60202	Gear Case Bottom Cover	1
51	QG129-131-ABED04-1801	Screw M4x18	4
52	QG129-297-7A60102	Right Rear Casing	1
53	QG129-303-7A60102	Right Front Casing	1
	QG129-132-8A60101	Screw M6x8	1
54	QG129-313-7A60202	Right Motor Cover	1
55	QG129-173-7A60101	Connection Wire 1	1
56	QG129-173-7A60102	Connection Wire 2	1
57	QG129-173-7A60103	Inductance Wire 1	1
58	QG129-173-7A60104	Inductance Wire 2	1
59	QG129-173-7A60206	Connection Wire 2	1

For pricing and availability, please contact our Spares Team on 01793 333212, option 1 for assistance.

Every effort is made to have parts available, depending on demand and cost effectiveness of producing, stocking and supplying individual components. Therefore, we reserve the right to supply certain parts as a complete assembly only.

# EC DECLARATION OF CONFORMITY

**Q Garden**



We Handy Distribution Ltd - SN3 5HY (Importer) declare that the product:

Designation: Electric 500W Hedge Trimmer  
Model(s): QG500ERHT  
Product Number: 1938287001  
Type/Serial No. As per rating label on machine  
Motor Power: 500W  
Voltage: 220-240V, 50Hz  
Electrical Safety Class: Class II

Complies with the following directives:  
2006/42/EC – Machinery Directive  
2014/30/EU - Electromagnetic Compatibility Directive  
2000/14/EC & 2005/88/EC - Outdoor Noise Directive

The conformity assessment procedure followed was in accordance with  
EN 60745-2-15:2009+A1:10; EN 60745-1:2009+A11:10; EN55014-1: 2006/+A1: 2009/+A2:2011;  
EN55014-2: 1997/+A1: 2001/+A2: 2008; EN61000-3-2: 2006/+A2: 2009/+A2: 2009;  
EN61000-3-3: 2013

Guaranteed Sound Power Level:  
(L<sub>WA</sub>) 103 dB(A)  
Emission Sound Pressure Level:  
(L<sub>PA</sub>) 91 dB(A) - uncertainty K: 3 dB(A)  
Vibration Measurement according to EN50636 Annex BB:  
2.61 m/s<sup>2</sup> - uncertainty K: 1.5 m/s<sup>2</sup>

Notified Bodies:  
Intertek Testing Services Shanghai  
Address(es):  
Building No.86, 1198 Qinzhou Road (North), Shanghai 200233, China

Authorised signatory & technical file holder

Date:

25/11/2020

Signature:

Name:

Mr Simon Belcher

Position:

Chairman

Company:

Handy Distribution Ltd

Address:

Murdock Rd, Dorcan, Swindon, Wiltshire, SN3 5HY.

## GJ HANDY & CO LTD USER WARRANTY POLICY

### Users Statement of Warranty

Each new machine is warranted against defective material or assembly of material under normal usage. The warranty applies to the original purchaser and covers faulty parts and the labour involved in replacing and repairing those parts, which are of original manufacture.

### Period of Warranty

The Handy (Petrol & Electric only), Webb (excludes Dynamic, Heritage, Legacy), Sanli Engine

- a) 2 years from the original date of sale to the first domestic user.
- b) 90 days from the original date of sale to the professional/commercial user.
- c) 90 days from the original date of sale when used for hire.
- d) A reduced warranty period of 90 days applies to those items which are subject to normal wear and tear (e.g. but not limited to wheels, tyres, cutter bars, cylinders, cutting blades, blade boss, belts, cables, nylon line & spool, collection bags, spark plugs).
- e) Engines are supplied with a separate warranty to the machine. The engine manufacturers warranty statement which will be supplied within the engine instruction manual. All enquiries and warranty repairs should be discussed with the engine manufacturer or approved warranty repair dealer.
- f) 90 days from the original date of purchase for Replacement Spare Parts (unless normal wear & tear component, which are covered for 30 days).
- g) **All machines' must be serviced within the first 12 months from the original date of purchase to comply with the warranty (if applicable), failure to do so will invalidate the 2nd year of the warranty.**

Webb Dynamic, Heritage & Legacy, Handy (All non-Petrol & Electric), Mowerland, Q-Garden

- a) 1 year from the original date of sale to the first domestic user.
- b) 90 days from the original date of sale to the professional/commercial user.
- c) 90 days from the original date of sale when used for hire.
- d) A reduced warranty period of 90 days applies to those items which are subject to normal wear and tear (e.g. but not limited to wheels, tyres, cutter bars, cylinders, cutting blades, blade boss, belts, cables, nylon line & spool, collection bags, spark plugs).
- e) Engines are supplied with a separate warranty to the machine. The engine manufacturers warranty statement which will be supplied within the engine instruction manual. All enquiries and warranty repairs should be discussed with the engine manufacturer or approved warranty repair dealer.
- f) 90 days from the original date of purchase for Replacement Spare Parts (unless normal wear & tear component, which are covered for 30 days).

All warranty repairs must be undertaken by an authorised service dealer. These dealers have been accredited by GJ Handy & Co Ltd and agree to only use genuine parts and follow our repair procedures.

#### Not covered by this warranty

- a) The warranty policy does not cover any depreciation or damages caused by ordinary wear, rusting or corrosion, lack of correct maintenance or operation, misuse, abuse, lack of transportation or accident.
- b) The warranty policy does not cover any costs necessary for the standard periodic maintenance services instructed by the operator's manual, or service parts replacement which would include oil, filters, tyres, belts, brake linings, fuses, blades, seals and other service parts unless it can be proven that the item has evidence of faulty manufacture.
- c) The warranty policy will not cover failure or damage caused as a result of parts or accessories being modified without the written approval of GJ Handy & Co Ltd.
- d) The warranty policy will not cover the unit if non-genuine parts have been fitted and as a result damage has occurred to the unit.
- e) The warranty policy is non-transferable and is only applicable to the original purchaser.

#### Disclaimer

- a) This warranty is only a remedy for defect of products. GJ Handy & Co Ltd will never warranty in terms of the merchantability or the fitness for a particular purpose.
- b) No person is authorised to make any warranties, representations or promises, expressed or implied, on behalf of GJ Handy & Co Ltd, or to modify the terms conditions or limitation of this warranty policy in any way.
- c) Neither GJ Handy & Co Ltd nor any company affiliated with GJ Handy & Co Ltd shall be liable in any event or manner whatsoever for incidental or consequential damages or injuries, including, but not limited to, loss of crops, loss of profit, out of pocket expenses or profits, rental of substitute equipment or other commercial losses.

#### General

- a) Most warrantable failures show up within the first few weeks of use. These failures are usually straightforward and warranty assessment is relatively easy.
- b) Failures relating to cutter decks and belts need careful investigation, as the cause may not always be straightforward. Look for damage to blades and pulleys especially when the cutter belt or blade boss have snapped or cracked as this could be due to impact damage.
- c) Customers should always refer to the operator/instruction manual when any disputed problem arises, you will find most areas covered within the manual.

NOTES

NOTES



If you require assistance with regards to the contents or operation of the machine, please contact us:

Tel: 01793 333212

Email: [customerservice@handydistribution.co.uk](mailto:customerservice@handydistribution.co.uk)

Opening hours weekdays:

February to October 8:30am - 5:30pm

November to January 8:30am - 5:00pm

(Closed Bank Holidays)

Distributed by  
Handy Distribution,  
Murdock Road,  
Dorcan,  
Swindon,  
Wiltshire,  
SN3 5HY,  
UK