

Advanced engine-powered lawnmower



SANLI | **LS 40**

www.sanli.co.uk



PLEASE KEEP THIS MANUAL IN A SAFE PLACE

Summary

1. Introduction	4
2. Safety instructions	5
2.1 Safety labels and symbols	5
2.2 Before using the mower	6
2.3 When using the mower	6
2.4 After using the mower	7
3. Usage Guidelines	8
3.1 Preparing the mower for work	8
3.11 Mower assembly	9
3.12 Filling the mower's engine with oil	9-10
3.13 Filling the fuel tank	10
3.14 Adjusting the Cutting Height	10
3.2 Using the mower	11
3.21 Starting the mower	11
3.22 Stopping the mower	12
3.3 Cleaning, storage, transportation and maintenance	13
3.31 Cleaning the mower	13
3.32 Storing the mower	13-15
3.33 Mower maintenance	15-15
3.34 Maintenance schedule	18
4. Specifications	18
5. Troubleshooting	20
6. Environmental Protection	21
7. After sales service	21
8. Warranty	22
9. Declaration of Conformity	23
Notes	23-23
Warranty registration card	27-28

Model LS 40

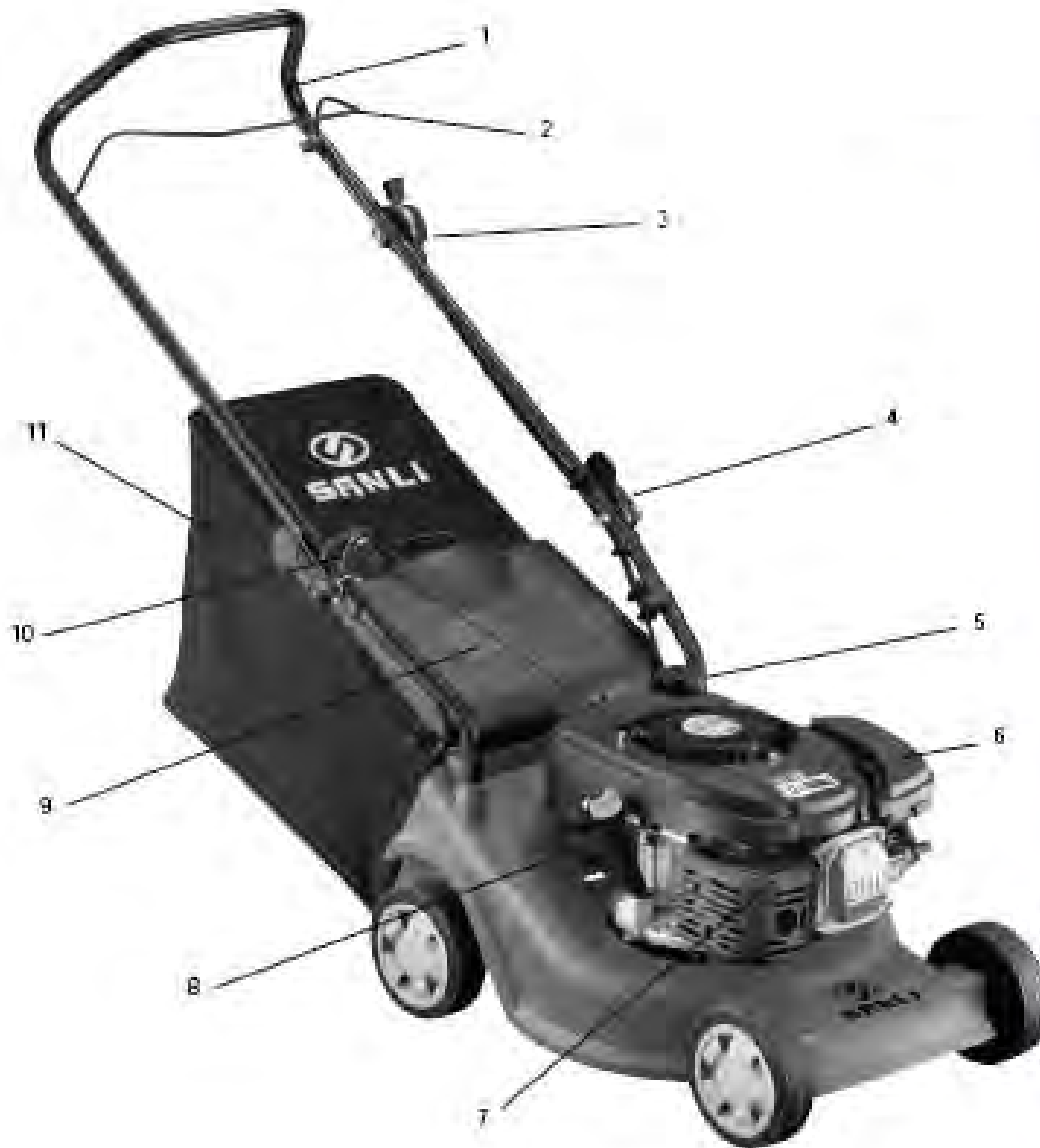

MOWER DESCRIPTION

1	Handlebar	7	Spark plug
2	Operator lever	8	Oil filler and dipstick
3	Throttle control	9	Rear protection
4	Quick-release handlebar clamp	10	Starter rope
5	Fuel tank	11	Grass collection bag
6	Air cleaner		

Parts supplied: spark plug key, wrenches, 2 hose-clamps

1. Introduction

Thank you and congratulations on your purchase of a new SANLI mower. We are confident that this equipment, when properly maintained and adjusted, will give you many years of trouble-free operation enabling you to fully appreciate its quality, performance and ease of use.

This mower has been designed and manufactured with utmost care in accordance with SANLI's strict standards of safety, reliability and ease of operation.

Please read this manual carefully and familiarise yourself with all of the mower's controls before using the machine for the first time.

Please adhere strictly to all warnings, explanations and instructions given in this manual to ensure safe and optimal use of your SANLI mower.









PLEASE KEEP THIS OPERATOR'S MANUAL IN A SAFE PLACE

2. Safety instructions

Always follow the instruction given in this manual when using the mower.

2.1 Safety labels and symbols

IMPORTANT: A number of the labels and symbols illustrated below will be found on your mower. Please study them and learn their importance. Correct interpretation of these symbols will result in efficient use and reduced risks.

	Danger ! Warning ! Attention ! This symbol highlights a danger, a warning or a caution. It indicates that the operator's safety is at risk.
	Read the manual The manual contains information intended to draw attention to possible safety issues and deterioration of the machine as well as helpful tips for getting started, correct mower use and maintenance. Please respect all of the warnings, explanations and instructions given in this manual for safe and optimal use of the mower.
	Risk of flying objects or debris Be aware that there is a risk of flying objects and/or debris when using the machine.
	Keep a safe distance The operator is responsible for the safety of others located in the working area of the machine. Do not cut the grass while other people, especially children or pets, are nearby.
	Risk of cuts or serious injury Keep hands and feet well clear of the cutting chamber when starting the engine and when the engine is running.
	Immobilise the machine Turn off the engine and remove the spark plug cap before cleaning, transporting, adjusting or leaving the machine unattended.
	Hazardous products This machine uses petrol and oil. Be very careful when filling, operating and moving the mower. Wear eye and hand protection when refilling the mower with fuel or oil.
	Wear protective equipment Wear eye and hearing protection when using the mower.

2.2 Before using the mower

- Study carefully the instructions given in this manual.
- Familiarise yourself with the mower's operation and how to use it properly.
- Never allow other people - especially children - to use the machine if they have not read and fully understood these operating instructions.
- If the mower is to be used by someone other than the owner, ensure that they have been given this instruction manual to read first.
- Never remove labels or safety devices from the machine.
- Check that all parts and components are securely fixed and attached.
- Ensure that the cutting blade and its fastener are in good condition and properly secured. Cutting edges should not be blunt or damaged. If necessary, remove and sharpen or replace the blade. Before doing this, always turn off the engine and remove the cap from the spark plug.
- Never use the mower when its protective grille, or any other safety device or guard, is damaged or missing.
- Check the oil level before each mowing session.
- Never alter the basic settings of the engine and do not overspeed.
- Before mowing, check the cutting area and remove any solid objects or debris (eg stones or twigs) that may be picked up and thrown out by the mower, injuring bystanders and damaging the cutting blade and engine.

2.3 When using the mower

- Mow only in good, clear daylight conditions.
- Be sure to comply with any local or national regulations governing when mowing may be carried out.
- Do not use the machine if you are feeling tired, unwell, have consumed alcohol or are under the influence of medicines/drugs.
- Never mow wearing loose clothing/shoes or with bare feet. Always wear long trousers and sturdy, non-slip footwear.
- Start the engine carefully in a clear, unobstructed area following the instructions for use. Keep hands and feet well away from turning blade.
- Never leave the engine running unattended or in an enclosed area where dangerous carbon monoxide fumes can accumulate.

- The mower's operator is responsible for the safety of others located in the working area of the machine. Never cut the grass while others, especially children or pets, are nearby. Doing so can heighten the risk of injury caused by stones or other debris being ejected from the machine when mowing.
- Never run when using the mower. Walk steadily guiding the machine carefully over the ground.
- The length of the handlebars provides a minimum recommended safe distance from moving and hot parts of the machine. Respect this distance.
- Never put hands or feet beneath the cutter deck or near to any other moving parts.
- Keep clear of all areas of the machine from which debris may be ejected.
- When mowing, avoid obstacles such as molehills, stumps, kerbs, posts and other obstructions which cannot be cut by the blade and may damage the cutting system. Do not work close to ditches or on soft/unstable ground or any other areas where there is risk of rollover.
- If you need to attend to or adjust the machine, always stop the engine and remove the cap from the spark plug..
- If the machine has to be lifted or transported, always stop the engine and remove the cap from the spark plug. Never lift or tilt the mower during starting or when the blade is turning.
- Use a ramp or get help from a suitable fit and healthy person when lifting, loading or unloading the mower.
- To avoid risk of fire, never start the mower where fuel has been spilled.
- Be especially careful when turning with the mower and when pulling it towards you.
- Maintain a well-balanced position on sloping ground and never mow on steep slopes. Be especially careful when changing direction on slopes. Always mow across a slope, never up and down.
- To avoid the risk of serious burns, never touch a hot engine or any of its parts unless wearing suitable protective gloves.
- Observe any local or national regulations relating to the use of engine-powered outdoor equipment.

2.4 After using the mower

- Allow the engine to cool before storing the mower in an enclosed area.
- Never store a mower with fuel in its tank in an area where petrol fumes may come into contact with a flame or spark. To prevent fire risk, keep the exhaust and the area around the fuel tank free of grass, leaves and oil.
- If you need to drain the fuel tank, do it outdoors using purpose-designed fuel suction pump.
- Remove grass, grease and oil from the mower before storing it.
- For maximum safety, replace worn or damaged parts immediately.
- Use only genuine original parts or those approved by SANLI UK.

3. Usage Guidelines

Making any unauthorised modifications to the mower (ie modifications that are unauthorised by SANLI UK and/or an appointed SANLI dealer) can make the machine unsafe and may lead to severe injuries during use. SANLI UK can accept no liability for machine failure or personal injury if the machine's owner and/or operator does not comply with this notice and/or with national safety regulations and guidelines regarding the use of engine-powered outdoor equipment.

3.1 Preparing the mower for work

3.11 Mower assembly

1. Mower shown in delivery position with handlebars folded (fig.1)
2. Attach the handlebars using the key supplied (fig.2)
3. Lock the handlebars in position using quick-release clamps (fig.3)
4. Fasten the starter cord to its support (fig.4)

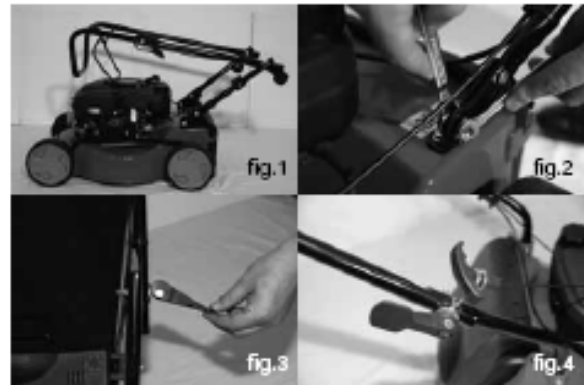

3.12 Filling the mower's engine with oil

For transport reasons, your new mower's engine does not contain oil when despatched from the factory. Before use, ensure that the mower contains oil.

WARNING: Never run the engine without oil even for a short period.

- Always use a high quality oil of API SF standards and SAE30 or 15W40 viscosity.
- When filling the engine with oil, position the mower on a firm, level surface. Unscrew the oil filler cap and remove the dipstick (fig.5).
- Slowly pour in the oil. The correct capacity of the engine's oil sump is 650 ml.
- Insert the dipstick up to the filler neck but do not screw it in. Remove the dipstick and read the oil level by holding the dipstick horizontally.
- The oil level must reach the maximum mark on the dipstick (fig.6)
- If too much oil has been added to the engine, the excess can be drained out by tipping the mower onto its side with the air filter and carburettor uppermost.



NOTE: THE OIL FILLER CAP MUST BE SCREWED IN FULLY BEFORE STARTING THE ENGINE. NEVER REMOVE THE FILLER CAP WITH THE ENGINE RUNNING.

3.13 Filling the fuel tank

WARNING: Petrol is highly inflammable. Always handle fuel with extreme care to avoid risk of burns, fire or explosion. The fuel tank should be filled before starting the engine. Your mower's engine runs on petrol alone - do not add oil to the petrol.

Always use unleaded petrol of a minimum 95 RON. Buy only the quantity of fuel that you plan to use in a month. Never transport and store petrol other than in a container suitable for the purpose, approved and labelled accordingly.

- Always refuel outdoors, never in an enclosed space or near a naked flame or heat source. Never smoke while filling the fuel tank.
- Do not unscrew the tank cap when the engine is running or when the mower is hot.
- To add fuel, unscrew the fuel filler cap.
- Slowly pour the fuel into the tank using the fuel container's spout (fig. 7) or a funnel.
- The tank's capacity is about 1 litre. Avoid spillages by not overfilling the tank. Leave about 13 mm space beneath the threaded collar to allow for fuel expansion.
- If fuel should overflow, do not start the engine. Move the mower away from the place of spillage and carefully wipe down the mower. Any attempt at starting should be avoided until petrol vapours have completely gone.
- Replace securely the caps on the fuel tank and the fuel container and place the latter in a secure place away from heat or direct sunlight.
- Before each mowing, visually inspect the condition of the mower's fuel tank and its cap, the fuel delivery pipe and the fuel filter.



If a fuel leak is seen or suspected, do not start the engine. Drain the fuel tank using a fuel suction pump and immediately contact an approved SANLI UK service dealer for advice.

3.14 Adjusting the Cutting Height

For best results, always adjust the cutting height of your mower to suit the mowing conditions and do not try to remove too much grass in one pass. Adjusting the cutting height of model LS40 is carried out wheel by wheel.

CAUTION: Never adjust the cutting height when the engine is running. Always remove the spark plug cap before making any adjustments.

- Remove the protective wheel trim to access the securing fastener (fig.8).
- Using the key provided with the mower, unscrew the wheel (fig.9).
- Position the wheel in one of the three height positions provided and retighten the fastener firmly (fig.10).
- Replace the trim to protect the wheel and fastener.
- Repeat the above operation on the three other wheels, ensuring they are all at the same height.





3.2 Using the mower

Before starting and using the mower, check for the presence and operation of safety devices. Also, check the condition of the blade and its securing bolt. If necessary, replace or repair defective items. Use only genuine SANLI parts or parts that have been approved by SANLI UK.

If possible, mow only when the grass is dry. If the grass is wet or excessively long, perform two cutting passes. Make the first pass at maximum cutting height to avoid overloading the mower. The second pass should be made at the required finished height. If grass builds up beneath the mower's chassis, stop the engine and remove the spark plug's cap before cleaning the underside of the cutter deck.

3.2.1 Starting the mower

- Before starting the engine, please read thoroughly the instructions regarding safe use of the mower (see pages 5 – 7).
- Slide the throttle lever to and fro several times to ensure that it is moving smoothly and correctly.
- Check that the fuel tap is in the ON position (fig.11) and that the engine's oil level is correct (see paragraph 3.12).
- Start the mower in a clear, level area. Do not start the engine if the cutting blade is resting on rough and uncut grass as this may cause difficulties at start-up.
- For a cold start, move the throttle lever to the position marked: 
- For a hot start, move the lever to the position marked: 
- Stand behind the handlebars. Move the operator control lever positioned in front of the handlebars rearwards so that the lever is resting against the handlebars (fig.12). Take hold of the starter handle firmly with the other hand.
- Pull back the starter until you feel resistance and then pull the handle firmly and briskly to turn the engine (fig.13).
- Repeat the above procedure as necessary until the engine starts.
- When starting from cold, gradually move the throttle lever to
- the full throttle position (as shown right) after a few moments of running. 

WARNING: The cutting blade turns when the engine is being started.



3.22 Stopping the mower

To minimise possible risk of accidents, the engine of your SANLI lawnmower is coupled to an operator control. When the operator control lever is released, it returns immediately to its rest position and the engine is automatically turned off.

To stop the mower, move the throttle lever to its stop position and release the operator control lever. The engine and the blade will stop turning automatically.



If there is a build-up of grass beneath the chassis, stop the engine, remove the spark plug's cap and wait until the engine has cooled before clearing the grass.

3.3 Cleaning, storage, transportation and maintenance

Before working on the cutting system of the machine, switch off the engine and remove the spark plug's cap.

3.31 Cleaning the mower

- Cut grass is damp. Regular cleaning after each use will ensure better functioning of the mower and reduce the risk of corrosion or seizure.
- Having finished mowing, allow the engine to cool then remove accumulated grass clippings from and around the engine with a brush.
- Clean the grass collection bag annually with a brush or gentle spray of water.
- Disconnect the spark plug's cap and tilt the mower on its side with the air filter and carburettor uppermost.
- Remove any remaining cut grass from the cutting system with a scraper and a brush.
- Reposition the mower onto its four wheels.
- Do not use a pressure washer or hot water to clean the mower. Be careful to avoid soaking parts such as the engine, air cleaner, wheel bearings and metal fastenings. Dry off the machine before storing by leaving it running for a few minutes on a flat, clear surface to prevent corrosion or seizure.

3.32 Storing the mower

Store your mower in a dry, well-ventilated area, away from flames, sparks or heat sources. If the storage area is accessible to children, immobilise the machine by disconnecting the spark plug's cap.

Storing the mower beneath a tarpaulin or similar cover is not recommended as it may cause a build-up of condensation resulting in corrosion.

Extended shutdown and winter storage

Thoroughly clean the mower. Ideally, run the engine outdoors until the fuel tank is empty. Alternatively, empty any remaining fuel using a fuel suction pump. Turn the fuel tap to the OFF position (fig 13).

Dispose of discarded fuel safely and responsibly, remembering that petrol vapours can cause explosion or fire. Run the engine until any remaining fuel is consumed. Allow the engine to cool. Check the condition and cleanliness of the air cleaner (see page 17).

Remove the spark plug from the engine and pour a tablespoon of engine oil into the cylinder. Gently pull the starter rope several times to turn over the engine, distributing the oil to protect the cylinder over winter. Replace and tighten the spark plug.

At the start of the new season

Remove the spark plug and gently clean off any carbon deposits from the tip with a small copper wire brush, finishing off with petrol. Allow the spark plug to dry. Pull the starter rope several times to expel excess oil from the cylinder. Replace and tighten the spark plug. Fill the fuel tank with unleaded petrol (95 RON minimum) and move the tap to the ON position. Turn over the engine until it starts (see 3.21)

Before transporting the mower

Thoroughly clean the mower. Empty the fuel tank using a suction pump. Turn the fuel tap to its OFF position (fig. 14). Dispose of discarded fuel safely and responsibly, remembering that petrol vapours can cause explosion or fire. Run the engine until any remaining fuel is consumed. Allow the engine to cool. Remove the grass collection bag. Loosen the quick release (fig.15) and fold down the top section of the handles taking care not to bend the cables.

To avoid scratching the mower, insert corrugated cardboard or similar



padding between the upper and lower handlebars and the engine.
Due to the mower's weight, use ramps or seek assistance when lifting or loading the mower.

3.33 Mower maintenance

Cutting system

Before and after each mowing session, check that the blade, its attachment bolts and drive shaft are not damaged or excessively worn. Never try to straighten a bent blade. Replace a damaged, worn or bent blade as soon as possible. Use only genuine SANLI parts or those approved by SANLI UK. Excessive vibration when mowing is a good indication of a problem with the cutting system.

WARNING: Vibration from a bent or damaged blade can cause costly damage to the mower. Working with an excessively worn blade wastes fuel and can lead to injury if the blade becomes detached from the machine.

Sharpening the blade

For best mowing results, have the edges sharpened and the blade balanced at least once a year by a specialist service dealer or agent.

Removing the blade

Wear appropriate protective gloves to prevent possible injury when handling the blade. Disconnect the spark plug cap and tilt the mower on its side with air filter and carburettor side uppermost.

Holding the blade firmly in one hand, use a spanner or socket to loosen the blade screw.

Mounting the blade

Wear appropriate protective gloves to prevent possible injury when handling the blade. Disconnect the spark plug cap and tilt the mower on its side with air filter and carburettor side uppermost.

Check that all components (the blade, key, blade holder, screws and washers).are present, clean and in good condition.

Position the blade on its support with the cooling fins facing the engine. Check the correct alignment and matching of pads with the blade. The blade must be positioned precisely on its stand.

Tighten the screws connecting all of the components. Make a final visual

check that all parts are present and aligned before tightening the fixing bolt very firmly with a wrench while holding the blade firmly in one hand (NB wear suitable gloves).

Spark plug

Check the spark plug initially after the first five hours of mower use. Thereafter, maintenance of the spark plug should take place every 25 hours.

Remove the spark plug cap (fig.16) using a rotary motion and then remove the spark plug with the wrench provided (fig.17).

Clean off any carbon deposits using a copper brush and check the electrode gap with a feeler gauge (the gap should be ≈ 0.7 mm).

Replace and retighten the serviced spark plug and replace the cap.

If the spark plug is worn or damaged, replace with a new spark plug of the same or suitable type for the engine. If in doubt, contact a SANLI UK appointed dealer.



Air Filter

An air filter in poor condition will reduce the performance and life of the engine while making it harder to start. Regular checks are therefore essential, especially when using the mower in dusty conditions. Check and clean the air filter every 25 hours of use or more often if the engine is used in a dusty environment.

Remove the air box lid (fig.18) and carefully remove the foam filter cartridge. Clean the cartridge in a small bowl of warm water containing a few drops of washing-up liquid until it is perfectly clean and free from all traces of grease and dust. Rinse the filter cartridge in clean water and then squeeze gently to remove most of the water. Let it air dry until it is completely dry.



WARNING: Never clean the foam cartridge in petrol, white spirit or other solvents. These products will degrade the filter cartridge.

Clean the cover and inside of the air box with a clean lint-free cloth. Apply a uniform layer of oil to the outside of the cartridge filter with a brush (you can

use clean engine oil for this). Insert the filter cartridge into its housing and replace the airbox lid, ensuring that each component is in place and properly installed.

If the filter cartridge is damaged or is very dirty, replace it using a genuine SANLI part.

WARNING: Do not twist the cartridge to clean foam, as you could damage it.

The SANLI LSP46 mower is equipped with a dual filtration system comprising a foam pre-filter and a cartridge filter paper.

The maintenance of a foam pre-filter is identical to that of a foam cartridge filter, as described above. The cartridge filter paper should be cleaned with a vacuum cleaner. If it is dirty or contaminated with oil or petrol, replace it.

Clean the cover and inside of the air box with a clean cloth. Evenly apply a thin layer of oil to the outside of the cartridge filter with a brush (you can use clean engine oil for this). Replace the filter cartridge in its housing and then replace the lid of the air box, ensuring that each component is in place and properly installed.

Engine Oil

Checking the oil level

Position the mower on a firm, level surface. Unscrew the oil level dipstick (fig.18) and wipe dry. Insert the dipstick until it reaches the filler neck, but do not screw in. Remove the dipstick and check the oil level holding the dipstick horizontal. The oil level should be between the minimum and maximum oil level marks on the dipstick (fig.19). Add oil if necessary and repeat the above checking process. Running the engine without oil or with too little oil can cause serious engine damage.



fig.19



fig.20

Changing the oil

The first oil change should be carried out after the first 5 hours of mower use. Thereafter, change the oil after every 25 hours' use or at least once a year. Leave the engine running outdoors for several minutes to warm the oil and make it more fluid. Warning: Parts of the engine will become very hot and can cause severe burns.

Remove the spark plug cap and unscrew the oil level dipstick. Place a suitable container beneath the mower's oil filler pipe and tilt the mower onto its side

with the air filter and carburettor uppermost. Allow the oil to drain completely into the container. Return the mower onto its four wheels and fill the engine with new oil as described in section 3.12

Note: Dispose of used engine oil carefully, responsibly and in accordance with local or national regulations.

3.34 Maintenance schedule

Summary of regular maintenance required by the mower

Components \ Frequency	Before each mowing	After 5 hours	Every 25 hours or once a year minimum before winter lay-up
Cutting system	Check and verify its condition		Sharpen and balance blade. Replace worn or damaged blade.
Spark plug		Check	Clean and check the clearance of the electrodes. Replace if necessary.
Air Filter		Check	Clean the filter. Replace if necessary.
Oil	Check the level	Drain and renew	Drain and renew

4. Specifications

Consistent with our policy of continuous improvement, SANLI reserves the right to change the design and configuration of any of its products without notice or obligation. Therefore, please treat the text and images in this manual as being for illustrative purposes only. They may in no case serve as a basis for any legal claim.

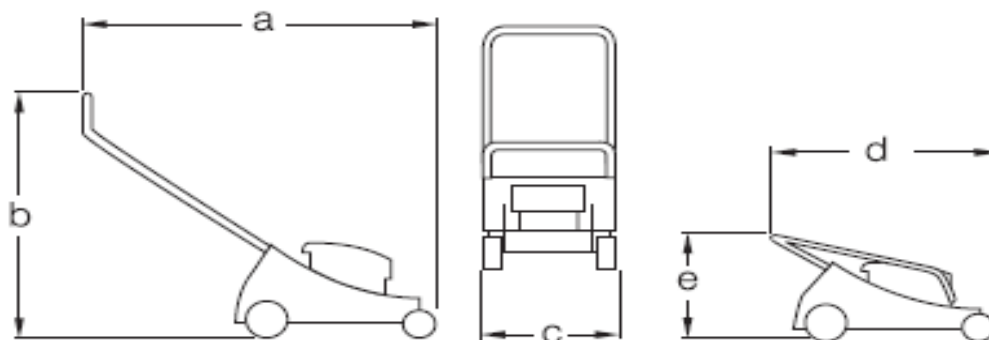

Model	LS40
-------	------

Type of machine	Engine-powered lawnmower
Version	Push
Cutting width	395 mm (15.5 in)
Engine	Sanli 350 OHV single cylinder 4 stroke - air cooled
Displacement	118 cc
Maximum power	2.3 kW (3hp) @ 4000 rpm
Maximum torque	5.4 Nm @ 3400 rpm
Rated speed	2900 rpm
Fuel type	Unleaded premium petrol – 95 RON
Fuel tank capacity	1 litre
Ignition	Electronic
Carburettor / throttle positions	4 positions, with starter
Starting system	Manual
Engine oil	15W40 or SAE30
Engine oil capacity	650 ml
Type of air filter	Foam
Forward speed	--
Cutting height adjustment	Individual wheels; 3 positions
Grass bag capacity	55 litres
Net Weight (empty)	24 kg
Spark plug type	TORCH F6RTC
Spark plug gap	0.6 - 0.8 mm
Sound pressure measured at working position	84.0 dB (A)
Acoustic power measured	92.5 dB (A)
Acoustic power guaranteed	94 dB (A)
Vibration AhW	3.8 m/s ²
Dimensions:(cms)	a = 126, b = 102, c = 45, d = 77, e = 53

5. Troubleshooting

Problem	Probable causes	Solution
The engine does not start	Incorrect throttle position Spark plug cap defective Fuel tank empty Fuel flow valve closed Ignition malfunction	Select the correct setting Replace the spark plug cap Fill fuel tank Open the fuel valve Contact a SANLI approved dealer
The engine fires, but starting is difficult	Operator control lever not properly engaged Engine oil too viscous for operating conditions	Press fully the operator lever Change the oil
The engine becomes excessively hot	Engine cooling fins blocked Low oil level	Clean engine exterior carefully Check the oil level
Heavy vibrations from the machine	Screws or bolts loose Blade attachment bolt loose Unbalanced or damaged blade	Tighten the screws/bolts Check blade attachment bolt Replace blade
The engine runs irregularly	Air filter dirty Spark plug dirty Poor quality or contaminated petrol	Clean or replace the air filter Clean spark plug Drain fuel tank and refill with unleaded 95 RON minimum
Fall in engine power	Air filter dirty Seized or blocked throttle control Lack of engine compression	Clean or replace the air filter Clean the throttle assembly Contact a SANLI approved dealer
Uneven or poor finish with yellowing of the longer/lower grasses	Blunt blade Cutting height set too low Engine speed is too low	Sharpen or renew the blade Raise the cutting height Advance throttle to maximum
Inadequate ejection of grass into collector bag and/or excess grass clipping left on surface	Engine speed is too low Cutting height is too low Worn or bent blade Blockage between deck and collector bag or bag blocked	Increase throttle to max Raise the cutting height Replace the blade Clear blockage/clean bag

6. Environmental Protection

To help protect the environment, SANLI recommends the following actions:

- Use 95 RON unleaded petrol
- Use a funnel to avoid spilling fuel during filling
- Do not leave the engine running unattended for long periods
- Do not overfill the fuel tank. Leave a gap of 13 mm below the neck of the tank to allow for expansion
- When changing the engine oil or draining the fuel tank, collect and dispose of spent liquids properly, safely and in accordance with local and national regulations.
- Keep the air filter and the spark plug clean and in good condition
- Please use your mower regularly and replace damaged or worn parts promptly.
- When your mower reaches the end of its economical working life, return it to your local SANLI dealer for recycling.

7. After sales service

For more information or for after sales service, please contact your local SANLI dealer or visit the SANLI UK website at www.sanli.co.uk.

An identification number is located on the name plate affixed to the mower and also to the back of this instruction book. Please quote this number when contacting a SANLI authorised dealer or service agent to request a repair, maintenance or a replacement part.

Use only original genuine SANLI parts or those approved by SANLI UK.

8. Warranty

PLEASE REGISTER YOUR MACHINE TO VALIDATE YOUR WARRANTY

To validate your warranty, please register your new mower with SANLI UK as soon as possible after purchase by returning the warranty card included at the back of this manual. You can also register on our website at www.sanli.co.uk/register/

SANLI UK guarantees the machine (including the engine) for 24 months from the date of purchase. SANLI UK guarantees to replace all defective parts due to a fault or a manufacturing defect. In no case will this guarantee result in a refund of hardware or direct or indirect damages.

To qualify for support under the SANLI UK guarantee, the applicant must submit as soon as possible a request or claim to an authorised SANLI UK service dealer or agent. A list of approved service dealers/agents is available on the website www.sanli.co.uk or by phoning 01235 861640.

Please provide details of the machine type and model number together with proof of purchase and the machine's serial number or a fully-completed warranty registration card.

Please note that this warranty does not cover:

- Improper use of the machine or any use that does not conform to the advice and recommendations given in this manual
- Poor, improper or inadequate maintenance
- Inadequate, excessive or incorrect use of engine oil
- Use of the machine in rental or hire applications
- Incorrect or improper machine installation, adjustment or starting
- Damage or loss that occurred during transportation or movement
- Damage resulting from a collision or a fall from height
- The cost of return shipping or packaging (any machine sent unauthorised with postage due will be returned untouched to the sender)
- Recognised mower wearing parts or consumables including, but not limited to, the cutting blade and its fixings, friction discs, air filters, engine oil, cables, wheels, wheel covers and bearings, the engine and its various components, the gearbox, the mower's cutter deck, handlebars and controls, the collection bag, safety guards, their fixings and hinge mechanisms, etc.

THE WARRANTY BECOMES NULL AND VOID AUTOMATICALLY IF:

- Changes are made to the machine without the express permission of SANLI UK.
- The machine is misused or the owner/operator fails to comply with the advice and procedures given in the instruction book and / or local or national regulations.
- Parts are fitted to the machine that are not genuine SANLI parts or have not been approved by SANLI UK

EC DECLARATION OF CONFORMITY

Fujian Jinjiang Sanli Engine Co., Ltd.

Declares that the following equipment manufactured by Fujian Jinjiang Sanli Engine Co.,Ltd conforms to the following Directive(s):2006/42/EC,2004/108/EC and 2000/14/EC of the European Parliament and of the council on the approximation of the laws of the Member States relating to the noise emission in the environment by equipment for use outdoors.

Equipment Category – Lawn Mower

Product Name/Model:Lawn Mower/ LS400P1C & LS40
Type/Serial No.: N/A
Cutting Width: 40 cm
Net installed power:3.5HP

The technical documentation is kept by:

Name:Mr.Liu Qingguo
Company: Fujian Jinjiang Sanli Engine Co., Ltd
Address: Wuli Industrial Park, Jinjiang, Fujian, 362263,P.R.China

The conformity assessment procedure followed was in accordance with annex VI of the Directive 2000/14/EC,and the Directive 2005/88/EC.

Notified Body:

TÜV SÜD Product Service GmbH- Ridlerstrasse 65-80339 MÜNchen (Germany)
TÜV SÜD Product Service GmbH- Westendstrasse 65-80686 MÜNchen (Germany)

Measured Sound Power Level: 92dB(A)
Guaranteed Sound Power Level: 94dB(A)

A copy of this certificate has been submitted to the European Commission and to EU Member State UK.

Place of Declaration: Wuli Industrial Park, Jinjiang, Fujian, 362263,P.R.China

Date: 05/12/2010

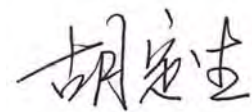

Signed by: Mr.Hu Dingsheng
Position in Company : General Engineer

Name and address of manufacturer or Authorised representative:
Fujian Jinjiang Sanli Engine Co.,Ltd.
Wuli Industrial Park, Jinjiang, Fujian, 362263,P.R.China



SANLI

LS 40

www.sanli.co.uk

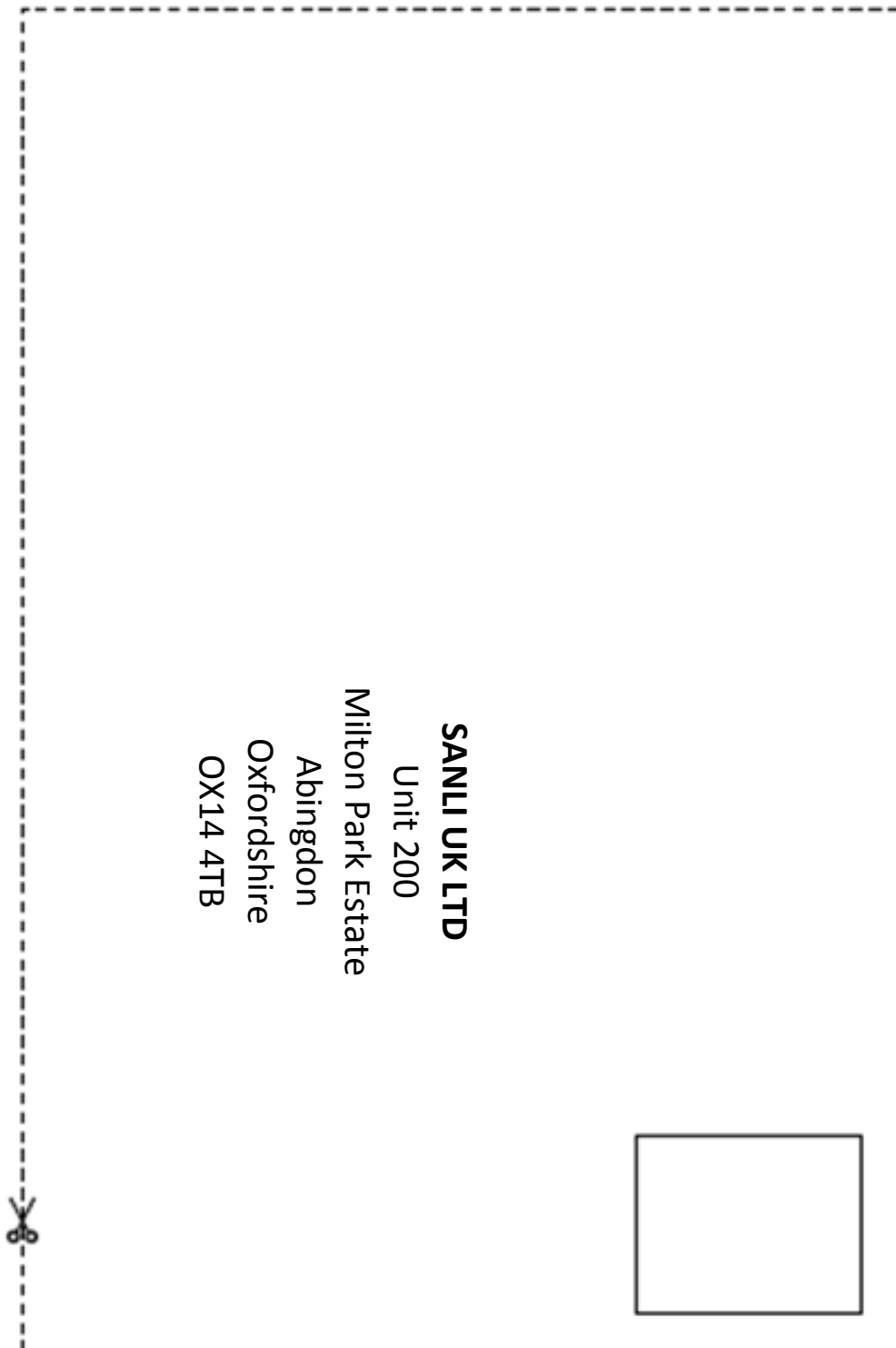

SANLI UK LTD

Unit 200

Milton Park Estate

Abingdon

Oxfordshire

OX14 4TB



WARRANTY REGISTRATION CARD

PLEASE REGISTER YOUR MACHINE TO VALIDATE YOUR WARRANTY

To validate your warranty, register your equipment with SANLI UK after its purchase by completing and returning the warranty card below or by registering on the website www.sanli.co.uk/register/.

Reference

LS40

Serial Number

S/N

GUARANTEE



USER

Surname

First name

Address

Town

Postcode

Country

Tel

Mobile

Email

By signing, the user certifies:

- that the instructions were provided and he/she has read the instructions regarding use, safety and maintenance;
- that he/she has been provided with instructions on how to use the machine safely and correctly by the seller;
- that he/she is aware of the conditions governing the guarantee contract and accepts them without reservation or restriction.

KEEP THIS PART

Reference

LS40

Purchase date

DISTRIBUTOR

Customer No:

Imprint / Company Name

Address

Town

Postcode

Country

Sanli UK Ltd

Unit 200

Milton Park Estate

Abingdon

Oxfordshire

OX14 4TB

www.sanli.co.uk

Check this box if you do not want to receive any commercial or technical information from SANLI UK.

Purchase date

Signature

Serial Number

S/N